

## GENERAL INFORMATION

|                           |  |
|---------------------------|--|
| LED Driver Type           | Constant Voltage (Class 2)                             |
| Maximum Wattage           | 60 Watts   |
| Input Voltage             | 120-277 VAC ± 10% Universal<br>120 VAC ± 10% Dedicated |
| Input Frequency           | 50/60Hz  |
| Total Harmonic Distortion | <20%   |

## CASE STYLE F: METAL



## ELECTRICAL SPECIFICATIONS

| Watts | Output Voltage | Max Output Current | Input Voltage | Input Power | Input Current | Power Factor | Efficiency | Hatch Part Number           |
|-------|----------------|--------------------|---------------|-------------|---------------|--------------|------------|-----------------------------|
| 60W   | 12 VDC         | 5.00A              | 120 - 277 VAC | 71W         | 0.65/0.28A    | >0.90        | 85%        | LV60-12N-UNV-F <sup>S</sup> |
|       | 14 VDC         | 4.30A              | 120 - 277 VAC | 71W         | 0.65/0.28A    | >0.90        | 85%        | LV60-14N-UNV-F              |
|       | 24 VDC         | 2.50A              | 120 - 277 VAC | 70W         | 0.65/0.28A    | >0.90        | 86%        | LV60-24N-UNV-F <sup>S</sup> |
|       | 24 VDC         | 2.50A              | 120 VAC       | 69W         | 0.64A         | >0.90        | 87%        | LV60-24N-120-F <sup>S</sup> |

## PRODUCT FEATURES

- Short circuit and overload protection
- Over temperature protection
- Suitable for dry and damp locations
- Withstanding voltage: I/P – O/P 2kVAC
- Operating temperature range: -40°C to 90°C (measured at Tcase)
- MTBF: 299,000 hours @ 40°C ambient (~70°C case temp)
- Inrush Current: <20A Max @230VAC for Universal input models, cold start 25°C
- Output Voltage tolerance +/- 5% @ 25°C
- 10% minimum load

## APPROVALS

- UL 8750 recognized component
- EN61000-3-2
- EMC: Meets FCC47 CFR Part 15 (Class B) consumer limits
- <sup>S</sup>UL879 SAM approved



## MECHANICAL SPECIFICATIONS: CASE STYLE F

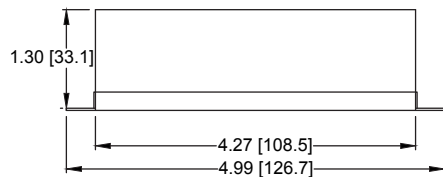
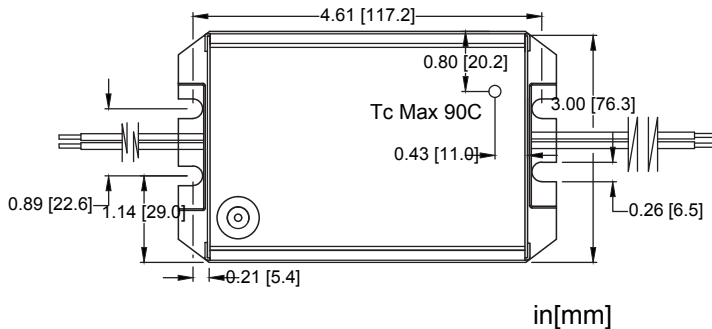

## DIMENSIONS [IN/MM]

|           |              |
|-----------|--------------|
| Length:   | 4.99 [128.7] |
| Mounting: | 4.61 [117.2] |
| Width:    | 3.00 [76.3]  |
| Height:   | 1.30 [33.1]  |

## WIRING INFORMATION

|         |                                  |
|---------|----------------------------------|
| Input:  | 12", Black (L), White (N) #18AWG |
| Output: | 12", Red (+), Blue (-) #18AWG    |

## PACKAGING INFORMATION

|           |             |
|-----------|-------------|
| Weight:   | 23 oz       |
| Quantity: | 30pc/carton |

## WARRANTY

- 5 year limited warranty

## RELATED PRODUCTS

- Case Style K: 9.50" x 3.00" x 1.35"
- Case Style I: 9.50" x 1.70" x 1.18"
- Case Style R: 9.64" x 1.87" x 1.50"

## GENERAL INFORMATION

|                           |  |
|---------------------------|--|
| LED Driver Type           | Constant Voltage (Class 2)                             |
| Maximum Wattage           | 60 Watts   |
| Input Voltage             | 120-277 VAC ± 10% Universal<br>120 VAC ± 10% Dedicated |
| Input Frequency           | 50/60Hz  |
| Total Harmonic Distortion | <20%   |

## CASE STYLE F: METAL



## PERFORMANCE CURVES

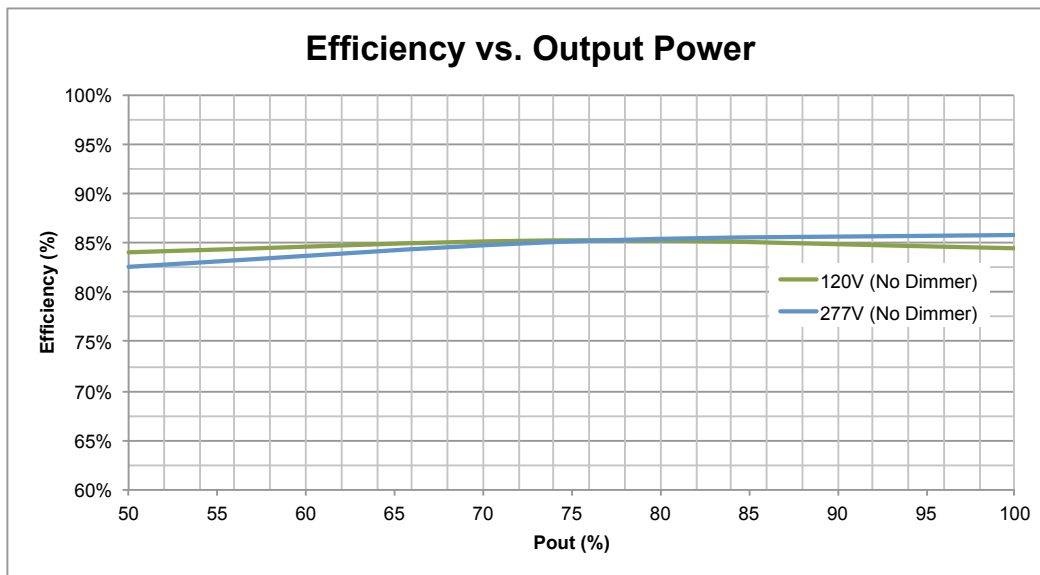

Measurements made on model LV60-12N-UNV-F.

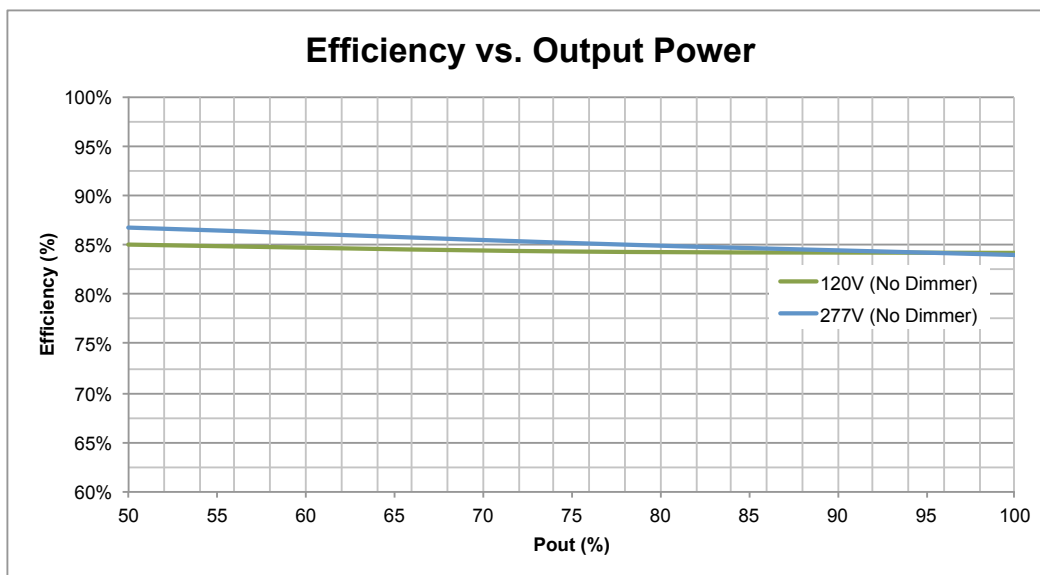

Measurements made on model LV60-24N-UNV-F.

Efficiency and PF measured at 25°C.

## GENERAL INFORMATION

|                           |  |
|---------------------------|--|
| LED Driver Type           | Constant Voltage (Class 2)                             |
| Maximum Wattage           | 60 Watts   |
| Input Voltage             | 120-277 VAC ± 10% Universal<br>120 VAC ± 10% Dedicated |
| Input Frequency           | 50/60Hz  |
| Total Harmonic Distortion | <20%   |

## CASE STYLE F: METAL



## PERFORMANCE CURVES

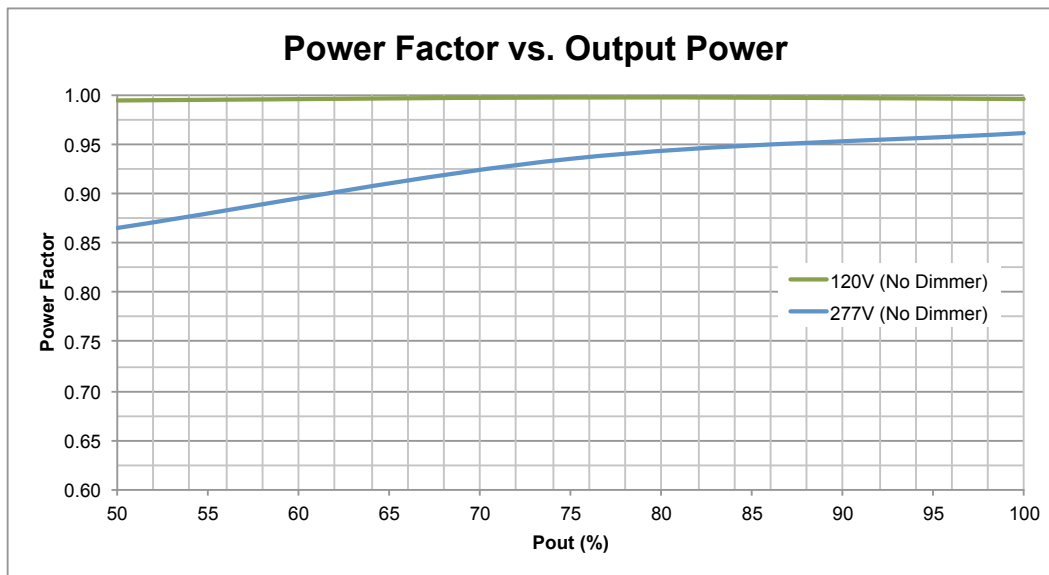

Measurements made on model LV60-12N-UNV-F.

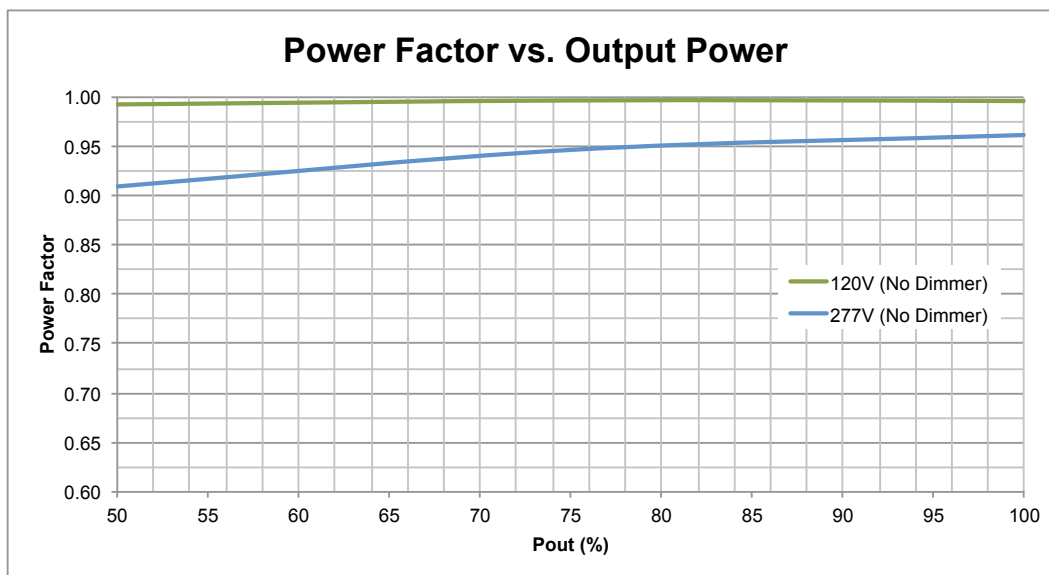

Measurements made on model LV60-24N-UNV-F.

Efficiency and PF measured at 25°C.

## GENERAL INFORMATION

|                           |  |
|---------------------------|--|
| LED Driver Type           | Constant Voltage (Class 2)                             |
| Maximum Wattage           | 60 Watts   |
| Input Voltage             | 120-277 VAC ± 10% Universal<br>120 VAC ± 10% Dedicated |
| Input Frequency           | 50/60Hz  |
| Total Harmonic Distortion | <20%   |

## CASE STYLE F: METAL



## PERFORMANCE CURVES

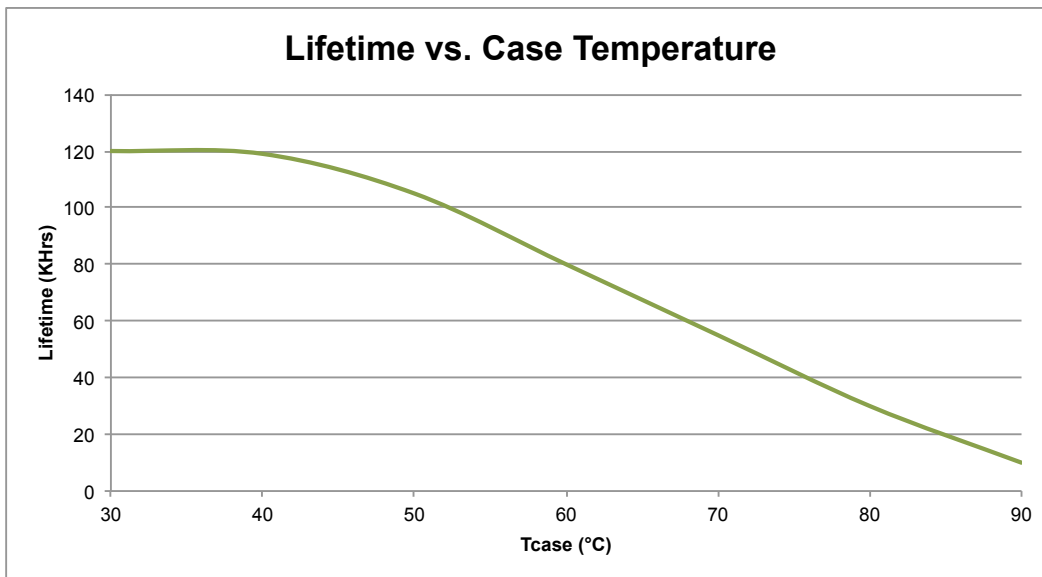

Measurements made on model LV60-12N-UNV-F.

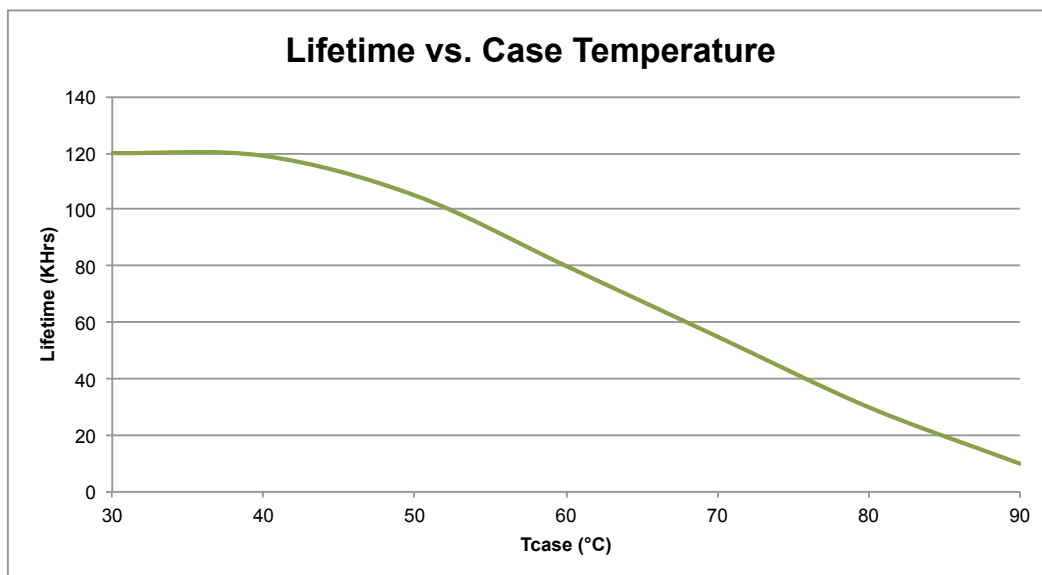

Measurements made on model LV60-24N-UNV-F.

Efficiency and PF measured at 25°C.