

XAC (0-10V) PROGRAMMABLE

CASE: XAC METAL

GENERAL INFORMATION

LED Drive Type	Programmable Constant Current, Class 2
Input Voltage	120-277 (+/-10%)
Input Frequency	50/60Hz
Programming Method	I-LOC Keys
Dimming Control	0-10V Dimming
Dimming Range	Dims to 1%*
Dimming Input Isolation	2.5kV
Source Current (Max)	1.2mA
Power Factor @ Full Load	>0.95%
Efficiency @ Full Load	>80%
LED Power Up Time	<500ms
Load Regulation	<3%
Line Regulation (Max Load)	<3%
Output Over Voltage Protection	Yes, Auto Recovery
Output Overload Protection	Yes, Auto Recovery
Output Short-Circuit Protection	Yes
Over Temperature Protection	Yes
EMI Compliance	FCC Part 15 Class B



ENVIRONMENTAL SPECIFICATIONS

Minimum Operating Temp.	-30°C
Maximum Case Temp. †	85°C
Maximum Storage Temp.	70°C
Maximum Relative Humidity	85% non-condensing
Transient Protection	NEMA SSL1-2010 Non-Roadway 2.5kV
UL Environment Rating	Dry & Damp
Sound Rating	Class A

*Do not dim below 10% @ 277V

†80°C Maximum Case Temperature for Warranty Purposes

ELECTRICAL SPECIFICATIONS

Max. Power (W)	Output Voltage (VDC)	Output Current (mA)	THD @ Full Load (120/277V)	Input Current (A) (120/277V)	Part Number
16W	24-46V	175-350mA	<10%/<15%	0.16/0.07	XAC16-0350Z-UNV-I
32W	24-46V	350-700mA	<10%/<20%	0.32/0.14	XAC32-0700Z-UNV-I
34W	17-32V	525-1050mA	<10%/<20%	0.34/0.15	XAC34-1050Z-UNV-I

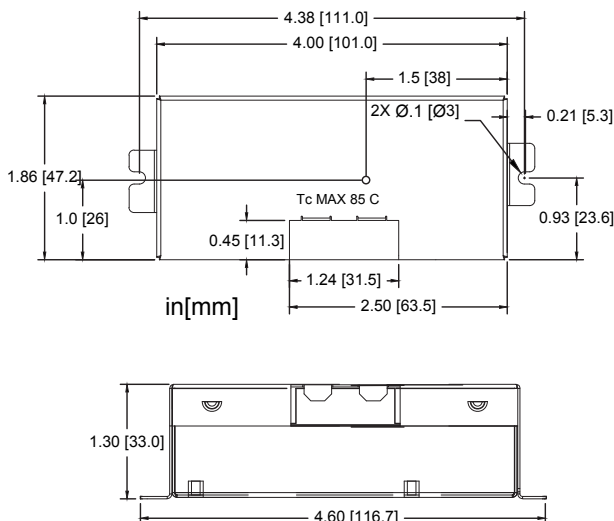

Wiring Information

Input:	6" # 18AWG Black (L), White (N), Green (G)
Output:	6" # 22AWG Red (+), Black/White (-)
Dimming:	6" #24AWG Purple (+), Grey (-)

Packaging Information

Weight:	0.57 lbs
Quantity:	50 pc/carton



Always confirm fit with a physical sample.
Specifications subject to change without notice.

For an I-LOC Demo visit:
<http://www.hatchlighting.com/about-i-loc/>

Hatch I-LOC Technology enables quick and easy setting of driver output current with the simple click of a key. Select the appropriate I-LOC key for the desired output current and click it into the driver.

The keys are **Interchangeable** across the Hatch I-LOC LED Driver product family and have a 50% to maximum output range. The 0.28 to 0.48 keys are designed exclusively for the Linear I-LOC family.

MODEL		XAC-16-0350Z-UNV-I			XAC-32-0700Z-UNV-I			XAC-34-1050Z-UNV-I		
Drive Factor	Part Number	Max Output (mA)	Voltage Range (V)	Max Output (W)	Max Output (mA)	Voltage Range (V)	Max Output (W)	Max Output (mA)	Voltage Range (V)	Max Output (W)
1.00	XA100	350	24-46	16	700	24-46	32	1050	17-32	34
0.98	XB098	343	24-46	16	686	24-46	32	1029	17-32	33
0.95	XC095	333	24-46	16	665	24-46	31	998	17-32	32
0.93	XD093	326	24-46	15	651	24-46	30	977	17-32	32
0.90	XE090	315	24-46	15	630	24-46	29	945	17-32	31
0.88	XF088	308	24-46	15	616	24-46	29	924	17-32	30
0.85	XG085	298	24-46	14	595	24-46	28	893	17-32	29
0.83	XH083	291	24-46	14	581	24-46	27	872	17-32	28
0.80	XI080	280	24-46	13	560	24-46	26	840	17-32	27
0.78	XJ078	273	24-46	13	546	24-46	26	819	17-32	26
0.75	XK075	263	24-46	13	525	24-46	25	788	17-32	26
0.73	XL073	256	24-46	12	511	24-46	24	767	17-32	25
0.70	XM070	245	24-46	12	490	24-46	23	735	17-32	24
0.68	XN068	238	24-46	11	476	24-46	22	714	17-32	23
0.65	XO065	228	24-46	11	455	24-46	21	683	17-32	22
0.63	XP063	221	24-46	11	441	24-46	21	662	17-32	22
0.60	XQ060	210	24-46	10	420	24-46	20	630	17-32	21
0.58	XR058	203	24-46	10	406	24-46	19	609	17-32	20
0.55	XS055	193	24-46	9	385	24-46	18	578	17-32	19
0.53	XT053	186	24-46	9	371	24-46	17	557	17-32	18
0.50	XU050	175	24-46	8	350	24-46	16	525	17-32	17

Adjusted Output Current Tolerance +/- 3%

Operating Range

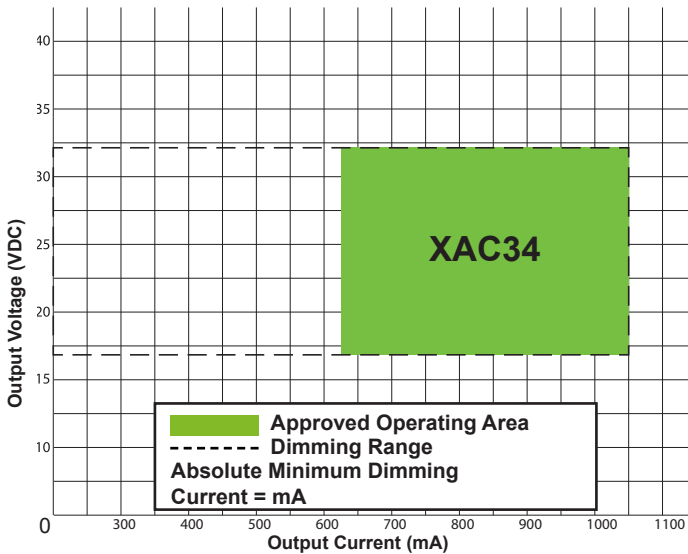
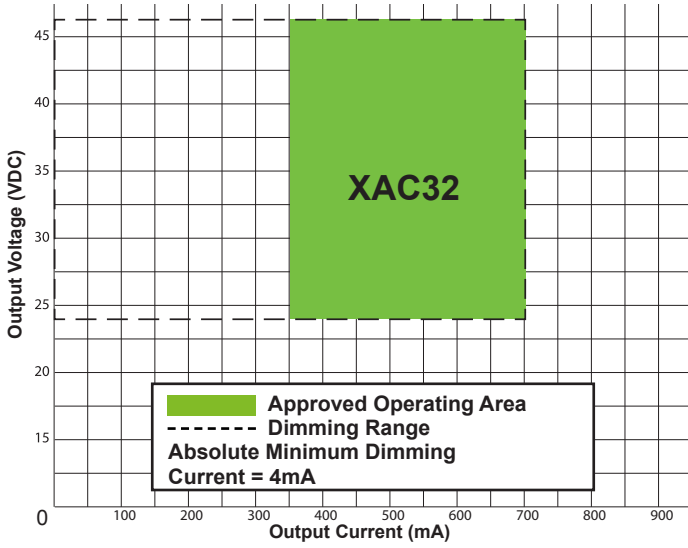
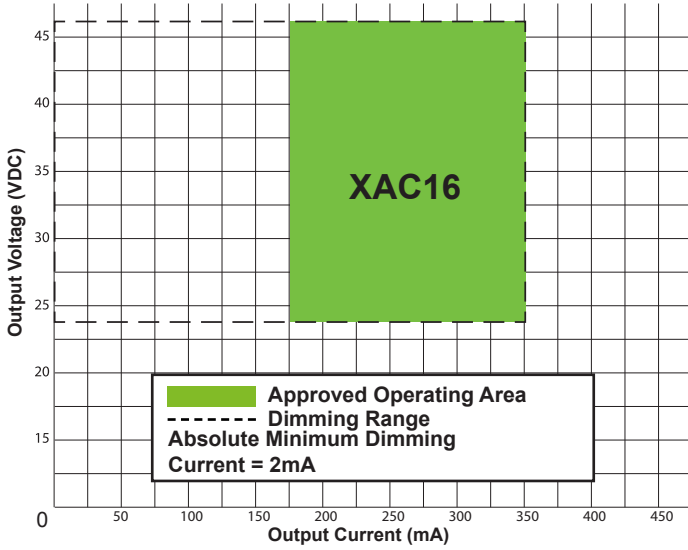

Dimming Range

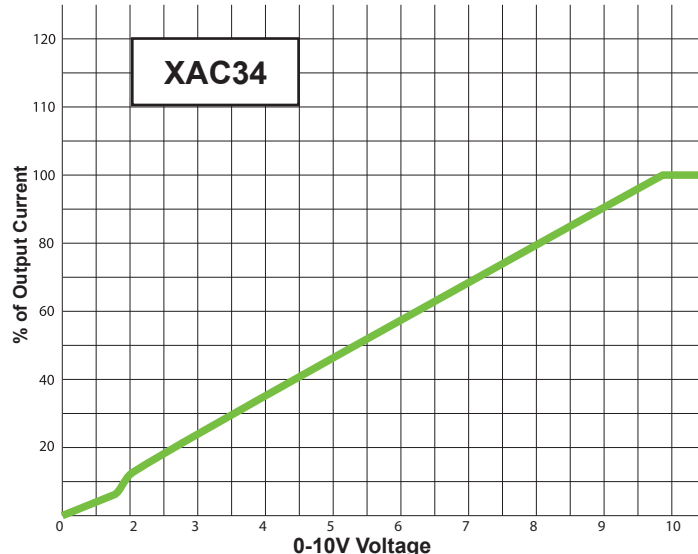
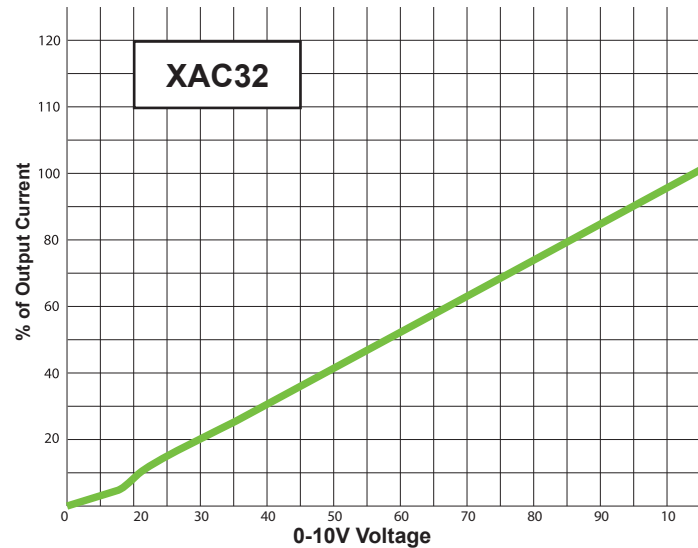
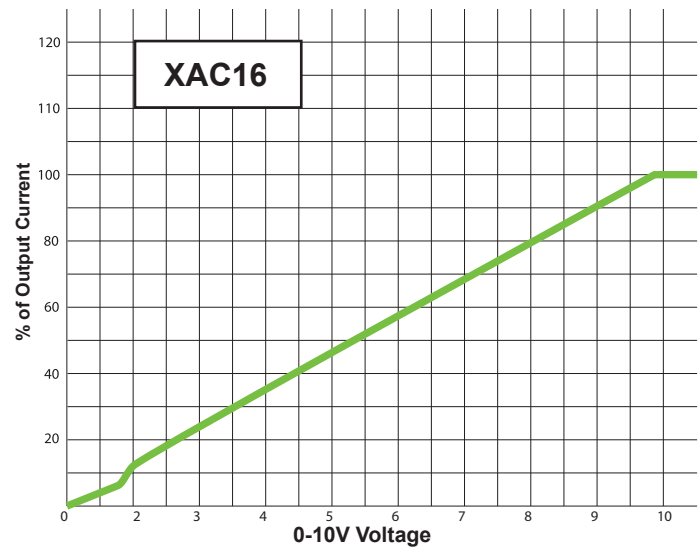

*0-10V XAC drivers dim to 1% of the adjusted output current.

Lifetime vs Case Temperature (Full Load)

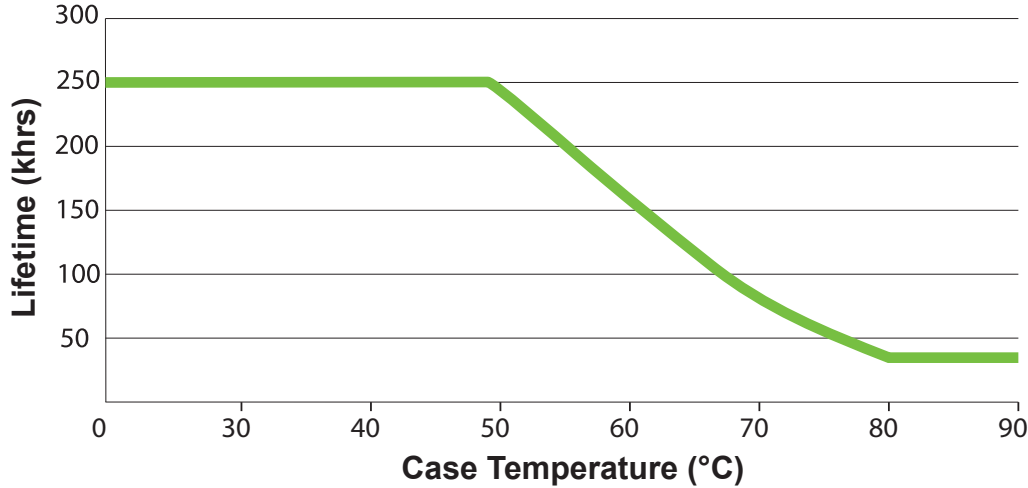

TL Information

Product	Key Range	Tref Max	Tref @ 40 °C
XAC16	0.50-0.65	90°C	66°C
	0.68-0.80	90°C	69°C
	0.83-1.00	90°C	61°C
XAC32	0.50-0.65	82°C	52°C
	0.68-0.80	90°C	58°C
	0.83-1.00	87°C	68°C
XAC34	0.50-0.65	90°C	66°C
	0.68-0.80	86°C	67°C
	0.83-1.00	76°C	59°C

Inrush Characteristics

Product	Input Voltage Vin (vrms)	Ipk (A)	T 50%pk (µS)
XAC16	120	1.70	32
	277	2.76	33
XAC32	120	3.75	37
	277	4.30	58
XAC34	120	3.74	36
	277	4.03	57

For an I-LOC Demo visit: <http://www.hatchlighting.com/about-i-loc/>