

LC SERIES

CONSTANT CURRENT LED DRIVERS

GENERAL INFORMATION

LED Drive Type	Constant Current Class 2
Maximum Wattage	16W
Input Voltage	120VAC (+/-10%) or 120-277VAC (+/-10%)
Input Frequency	50/60Hz
Power Factor @ Full Load	>0.9
Efficiency @ Full Load	Up to 83% (See Chart Below)
THD	<20%
Start-Up Time	<500ms
Output Current Tolerance	5%
Line Regulation	1% (Phase Dimming) 2% (0-10V Dimming)
Load Regulation (Max Load)	2%
Dimming	Phase or 0-10V Dimming (Min 10%)
Output Over Current Protection	Hiccup Mode
Output Short-Circuit Protection	Hiccup Mode
Over Temp. Protection	Hiccup Mode
EMI Compliance	FCC Part 15 Class B

CONSTANT CURRENT LED DRIVER CASE STYLE Q: POLYCARBONATE



ENVIRONMENTAL SPECIFICATIONS

Minimum Operating Temp.	-40° C
Maximum Case Temp.	+90° C
Maximum Storage Temp.	+85° C
Maximum Relative Humidity	95% Non-condensing
Transient Protection	2kV L-N, 4kV L/N-GND
UL Environment Rating	Dry & Damp
Sound Rating	Class A

APPROVALS



WARRANTY

- 5 year limited warranty

ELECTRICAL SPECIFICATIONS

Max. Power	Rated Current	Output Voltage (VDC)	Input Voltage	Dimming Type	Input Power	Input Current	Efficiency	Part Number
16W	0-10V Dimming							
	350mA	15-46 VDC	120 - 277 VAC	0-10V Dimming	20W	0.19/0.09A	83%	LC16-0350Z-UNV-Q * ‡
	500mA	10-32 VDC						LC16-0500Z-UNV-Q ‡
	700mA	10-23 VDC						LC16-0700Z-UNV-Q ‡
	Phase Dimming							
	350mA	15 - 46 VDC	120 VAC	Phase Dimming	20W	0.19A	80%	LC16-0350P-120-Q*
500mA	10-32 VDC	LC16-0500P-120-Q						
700mA	7-23 VDC	LC16-0700P-120-Q						

Custom output current available on Made to Order basis.

* Class 2 US Only ‡ Class P

LC SERIES

CONSTANT CURRENT LED DRIVERS

SIZING INFORMATION: CASE STYLE Q

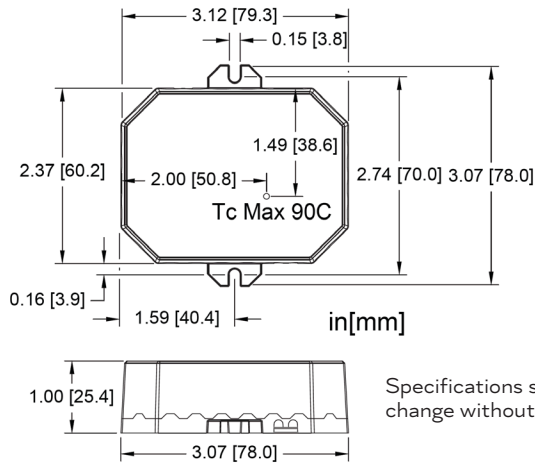

WIRING INFORMATION

Input	12", Black (L), White (N) #18AWG
Output	12", Red (+), Blue (-) #18AWG
Dimming	12", Purple (+), Pink (-) #22AWG

PACKAGING INFORMATION

Package Weight	6.4oz
Quantity	50pcs/carton

PERFORMANCE CURVES

Efficiency Vs. Output Power

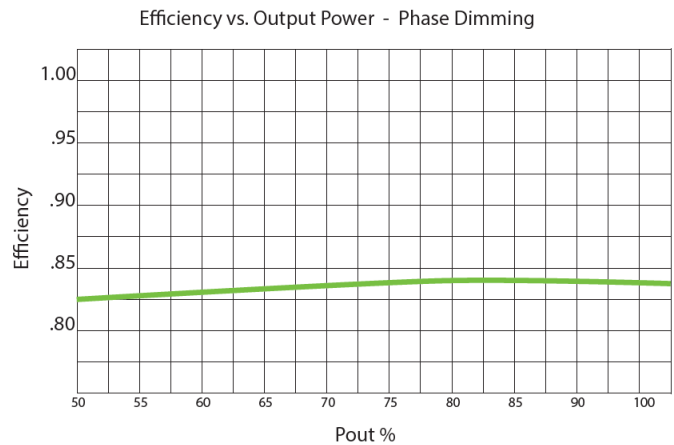
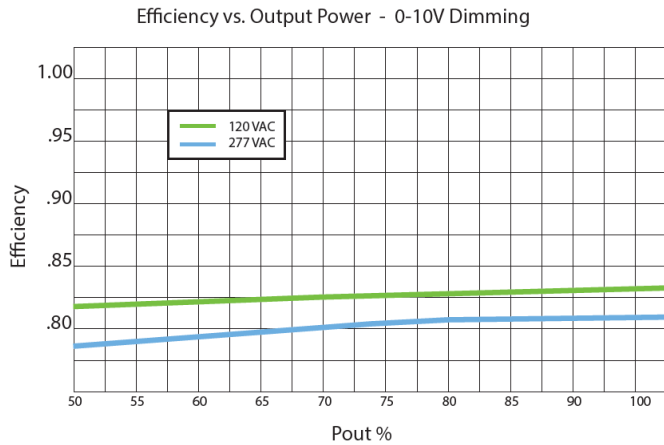

LC SERIES

CONSTANT CURRENT LED DRIVERS

PERFORMANCE CURVES

Power Factor Vs. Output Power

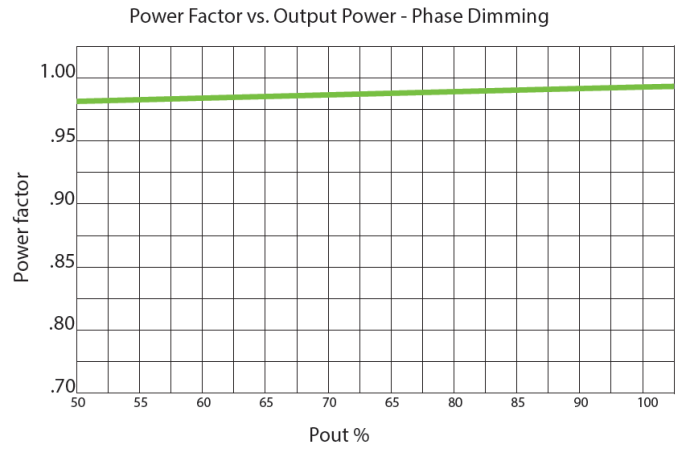
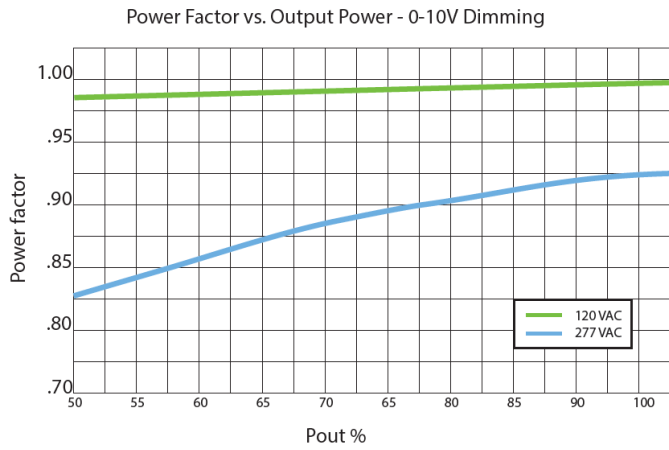

Dimming Curves

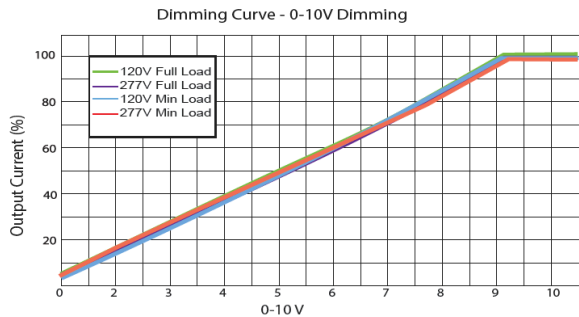
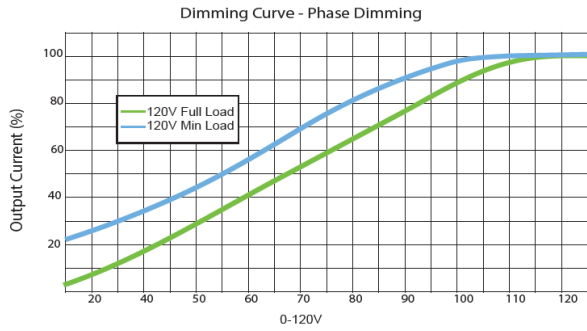

Lifetime Vs. Case Temperature

