

LC SERIES

CONSTANT CURRENT LED DRIVERS

GENERAL INFORMATION

LED Drive Type	Constant Current Class 2
Maximum Wattage	25W
Input Voltage	120VAC (+/-10%) or 120-277VAC (+/-10%)
Input Frequency	50/60Hz
Power Factor @ Full Load	>0.9
Efficiency @ Full Load	Up to 81% (See Chart Below)
THD	<20%
Start-Up Time	<500ms
Output Current Tolerance	5%
Line Regulation	1% (Phase Dimming) 2% (0-10V Dimming)
Load Regulation (Max Load)	2%
Dimming	Phase or 0-10V Dimming (Min 10%)
Output Over Current Protection	Hiccup Mode
Output Short-Circuit Protection	Hiccup Mode
Over Temp. Protection	Hiccup Mode
EMI Compliance	FCC Part 15 Class B

CONSTANT CURRENT LED DRIVER CASE STYLE Q: POLYCARBONATE



ENVIRONMENTAL SPECIFICATIONS

Minimum Operating Temp.	-40° C
Maximum Case Temp.	+90° C
Maximum Storage Temp.	+85° C
Maximum Relative Humidity	95% Non-condensing
Transient Protection	2kV L-N, 4kV L/N-GND
UL Environment Rating	Dry & Damp
Sound Rating	Class A

APPROVALS



WARRANTY

- 5 year limited warranty

ELECTRICAL SPECIFICATIONS

Max. Power	Rated Current	Output Voltage (VDC)	Input Voltage	Dimming Type	Input Power	Input Current	Efficiency	Part Number
25W	Dimming Models							
	**350mA	24 - 72 VDC	120 - 277 VAC	0-10V Dimming	30W	0.28/ 0.13A	80%	**LC25-0350Z-UNV-Q ‡
	*500mA	17 - 50 VDC					81%	*LC25-0500Z-UNV-Q ‡
	700mA	12 - 36 VDC					81%	LC25-0700Z-UNV-Q ‡
	1050mA	9 - 24 VDC					81%	LC25-1050Z-UNV-Q ‡
	Phase Dimming Models							
	**350mA	24 - 72 VDC	120 VAC	Phase Dimming	30W	0.29A	80%	**LC25-0350P-120-Q
	*500mA	17 - 50 VDC					81%	*LC25-0500P-120-Q
700mA	12 - 36 VDC	81%					LC25-0700P-120-Q	
1050mA	8 - 24 VDC	80%					LC25-1050P-120-Q	

Custom output current available on Made to Order basis. ** Non-Class 2 *Class 2 US Only ‡ UL Listed Class P

LC SERIES

CONSTANT CURRENT LED DRIVERS

SIZING INFORMATION: CASE STYLE Q

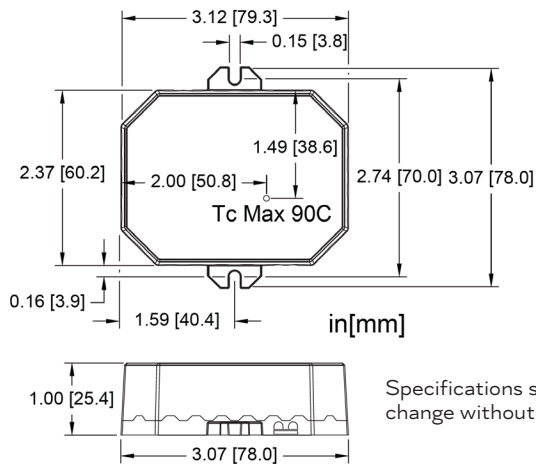

Specifications subject to change without notice.

WIRING INFORMATION

Input	12", Black (L), White (N) #18AWG
Output	12", Red (+), Blue (-) #18AWG
Dimming	12", Purple (+), Pink (-) #22AWG

PACKAGING INFORMATION

Package Weight	6.4oz
Quantity	50pcs/carton

PERFORMANCE CURVES

Efficiency Vs. Output Power

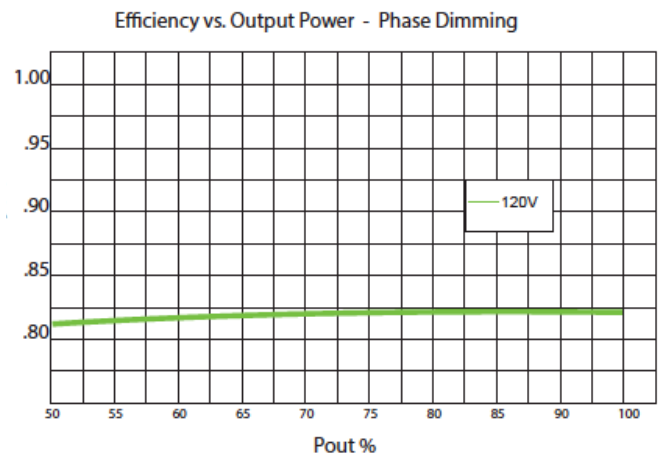
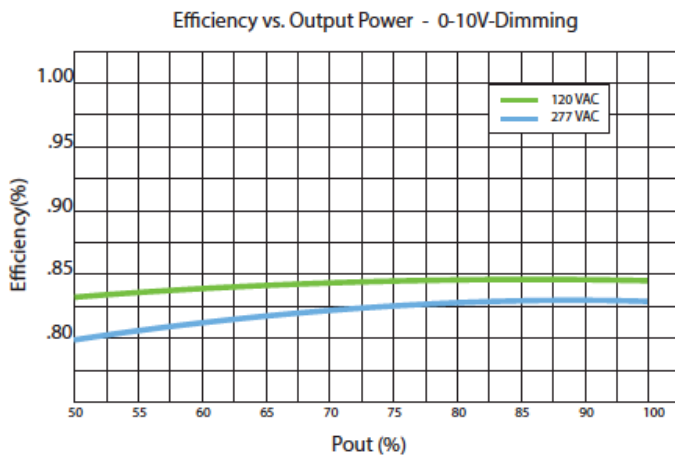

LC SERIES

CONSTANT CURRENT LED DRIVERS

PERFORMANCE CURVES

Power Factor Vs. Output Power

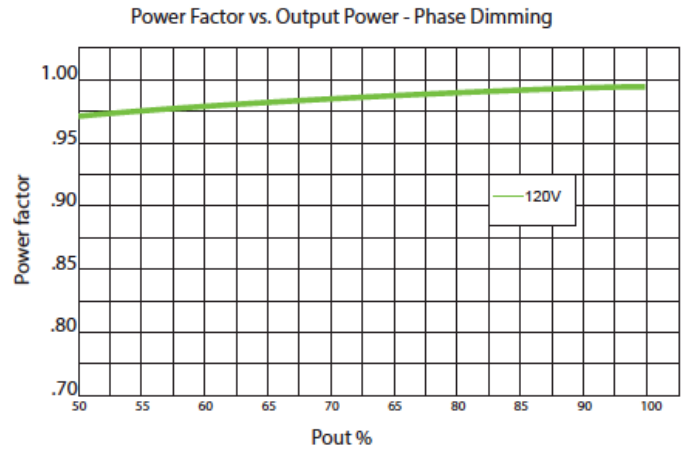
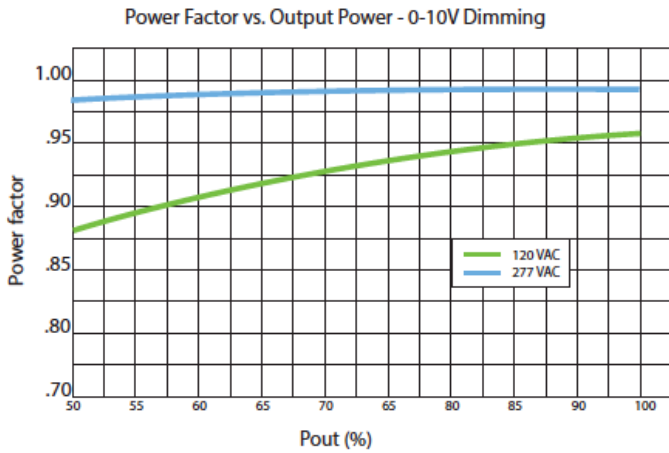

Dimming Curves

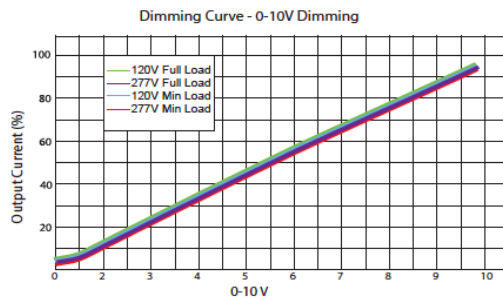
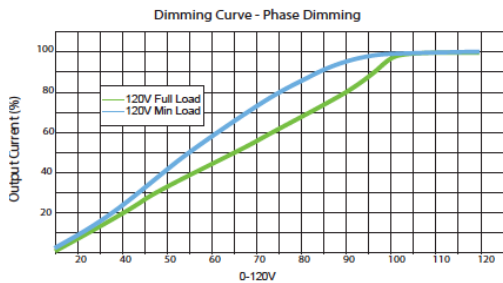

Output voltage range must be maintained throughout entire dimming range.

Lifetime Vs. Case Temperature

