



FOUNDATION SERIES LED DRIVERS

PRELIMINARY

(Subject to Change)

15W ROUND CASE STYLES

PROGRAMMABLE CONSTANT CURRENT LED DRIVERS

FEATURES

- Programmable Class 2 Output
- High Power Density
- Excellent Thermal Management
- Tri-Dim Capability (1% for Triac, ELV and 0-10V)
- Dim-to-off Capability
- Universal Input Range 120V-277V
- Dry & Damp Location Rated

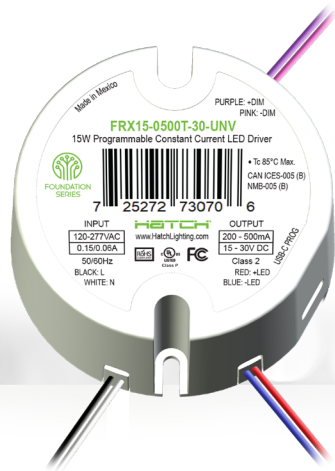

PROGRAMMING

- Foundations LED drivers are software programmable using the Foundations Programming Portal accessed with the Google Chrome browser on Windows based PCs or Android devices when attached with the Foundation USB Connector. The LED driver does not need to be powered on during programming.
- The Foundations Programming Portal is a secure cloud-based application requiring customer registration. The Portal provides a simple interface to set parameters on the LED drivers for output current and dimming parameters including dim-to-off. Profiles can be generated and stored for the manufacturing environment with easy recall in the menu system. The Portal also provides data records to supplement manufacturing quality systems with model number, date of programming, programmed parameters, and serial number.
- The Foundation USB Connector gives the physical interface between the Foundations LED Driver and the programming device which can be a Windows based PC or an Android device. The Foundation USB Connector is powered by the USB port on the PC or Android device and uses a common USB-A connection to the PC or Android device and a common USB-C cable to attach the Foundation USB Connector to the Foundations LED Driver.



APPROVALS / CERTIFICATIONS



Patents Pending

ELECTRICAL CHARACTERISTICS

Maximum Power	Programmable Current Range	Output Voltage (VDC)	Input Voltage	Dimming Type	Part Number
15W	150-350mA	20-42	120-277 VAC	Tri-Dim (TRIAC, ELV and 0-10V)	FRX15-0350T-42-UNV
	200-500mA	15-30			FRX15-0500T-30-UNV

INPUT SPECIFICATIONS

	FRX15-0350T-42-UNV	FRX15-0500T-30-UNV
Input Voltage	90-305 VAC (120 / 277 VAC Nominal)	90-305 VAC (120 / 277 VAC Nominal)
Input Frequency	47-63Hz (50 / 60 Hz Nominal)	47-63Hz (50 / 60 Hz Nominal)
Input Current (120 / 277)	0.14 / 0.07 A	0.15 / 0.06 A
Power Factor (120 / 277)	0.96 / 0.97	0.96 / 0.97
THD (120 / 277)	5.6% / 9.0%	3.0% / 5.0%
Efficiency (120 / 277)	84.0% / 82.6 %	83.8% / 83.7%

Input Characteristics: Nominal Input Voltage, Max Load, No Dimmer

OUTPUT SPECIFICATIONS

	FRX15-0350T-42-UNV	FRX15-0500T-30-UNV	Notes
Output Current Programmable Range	150 – 350 mA	200 – 500 mA	
Output Voltage Range	20 – 42 Vdc	15 – 30 Vdc	
Output Current Load Regulation	2%	2%	Nominal input voltage, full programmed current range
Output Current Line Regulation	2%	2%	Max load voltage, full programmed current range
Output Current Overshoot	10%	10%	<500ms
Start Up Time	<500ms	<500ms	
Standby Power (120 / 277)	0.21 / 0.74W	0.25 / 0.69W	

Start Up Time: 120V; Power Supply for 0-10V, SLV-600P for forward phase, SELV300P for reverse phase

PROTECTIONS

Output Overcurrent Protection: Hiccup Mode with Auto Recovery. When the load current exceeds the programmed current by 15%, the output will go into hiccup mode and will auto-recover when the fault is removed.

Output Short Circuit Protection : Hiccup Mode with Auto Recovery. When the output leads are shorted, the output will go into hiccup mode and will auto-recover when the fault is removed.

Over Temperature Protection: Fold Back with Auto Recover. When the internal temperature sensor senses the LED driver above the rated Tc by 60C, the output current will fold back below the programmed current output and will recover when the temperature stabilizes to the normal value.

ENVIRONMENTAL SPECIFICATIONS

	Min	Nom	Max	Notes
Max Case Temp			90°C	At Tc Location
Storage Temp	-40°C		85°C	
Humidity			95%	Non-condensing
Acoustic Noise		<25dB		
MTBF (Hrs)			350,000	At Max Load and Tc <70°C

SAFETY & EMC COMPLIANCE

UL, cUL	UL8750, Class P
FCC 47CFR Part 15	ANSI C63.4:2009 Class B (Consumer Limits) @120VAC, Class A (Commercial) @277

SIZING INFORMATION - mm [in]

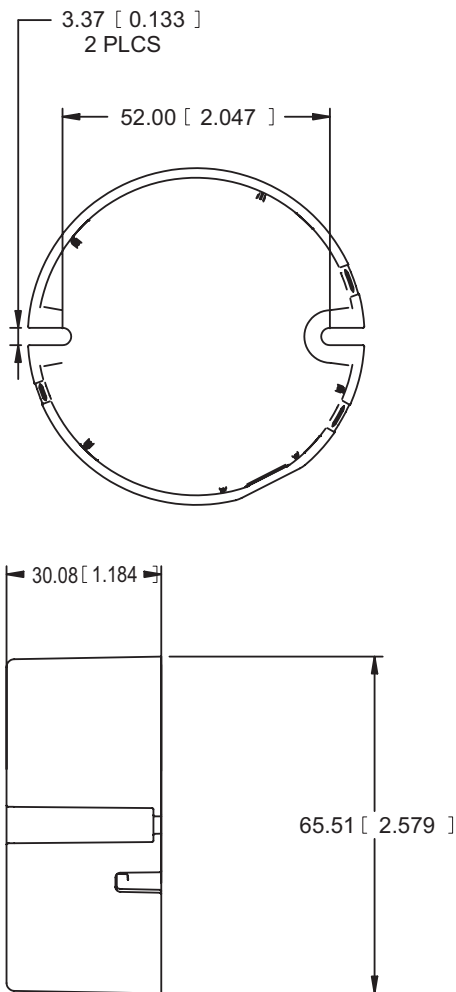

WIRING INFORMATION

Input	6" Black (L); 6" White (N); 18AWG
Output	6" Red (+); 6" Blue (-); 18AWG
Dimming	6" Purple (+); 6" Pink (-); 24AWG

PACKAGING INFORMATION

Package Weight	6oz
Quantity	50pcs/carton

PART NUMBER DECODING

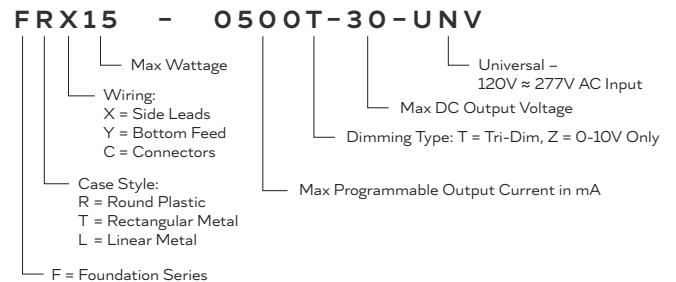

OUTPUT OPERATING REGION

FRX15-0350T-42-UNV

FRX15-0500T-30-UNV

STATEMENTS AND NOTATIONS

DIMMING CHARACTERISTICS - 0-10V

Hatch Foundation series source current for the 0-10V dimming connections, therefore, use 0-10V dimmers that sink current. The dimming is related to the programmed output current.

The dim voltage can be set for max and min to match with a preferred dimming control system. The driver is shipped with the upper voltage set to 10V and the lower voltage set to 1V. During programming, the upper voltage can be set to a value between 8V and 10V in 0.5V increments which corresponds to the voltage where the output will change from full output to dimming output. The lower voltage can be set from 0.4V to 2.0V in 0.1V increments which corresponds to when the light output will achieve the minimum dimming setting.

The driver ships with minimum dimming set at 1% and can be programmed to 5% and 10%, linear or logarithmic. Dim-to-Off can also be programmed as well as the dim-to-off voltage setting for turning off and turning on.

	Min	Typical	Max	Notations
Default Profile (V)	1		10	
Dim Range (%)	1%		100%	Default min dim 1%. Can be set via programming (1%, 5%, 10%)
Upper Voltage (V)	8	10	10	Upper voltage to achieve full light output. Adjustable in 0.5V increments
Lower Voltage (V)	0.4	1	2.0	Lower Voltage to achieve min. light output. Adjustable in increments of 0.1V
Current Supplied (mA)	0.23	0.25	0.27	Source current from driver to 0-10V control
Dim-to-Off Voltages for Turn On	0.6		1.8	Adjustable in increments of 0.1V. Must be set at least 0.2V lower than Lower Voltage
Dim-to-Off Voltage for Turn Off	0.4		1.6V	Adjustable in increments of 0.1V. Must be set at least 0.2V lower than Dim-to-Off Turn On Voltage

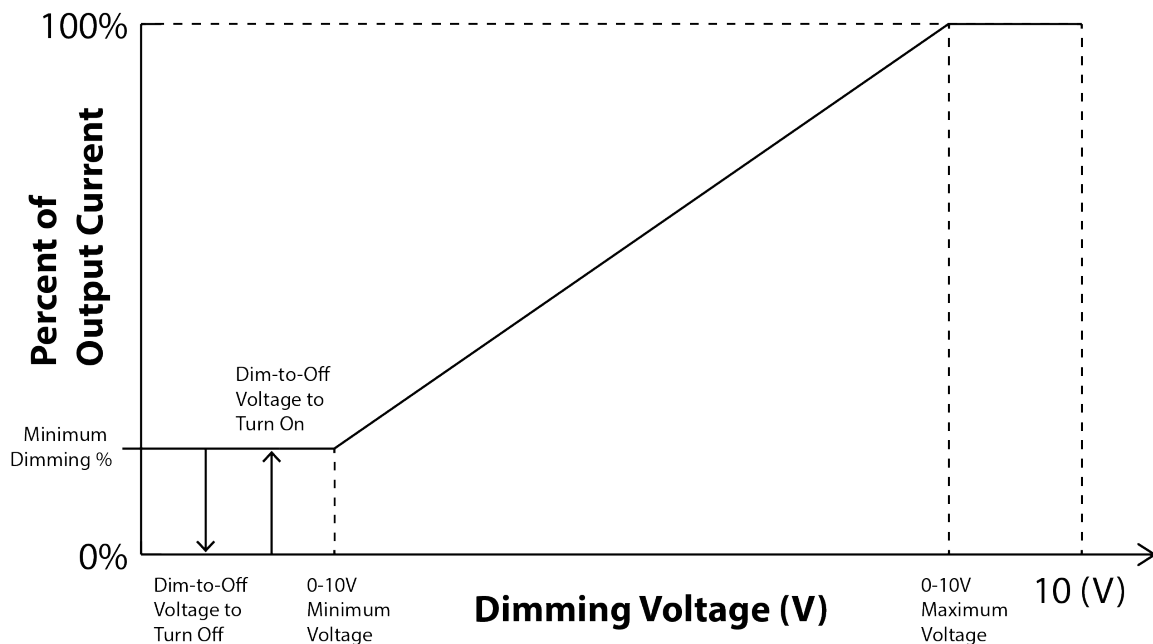

DIMMING CURVE

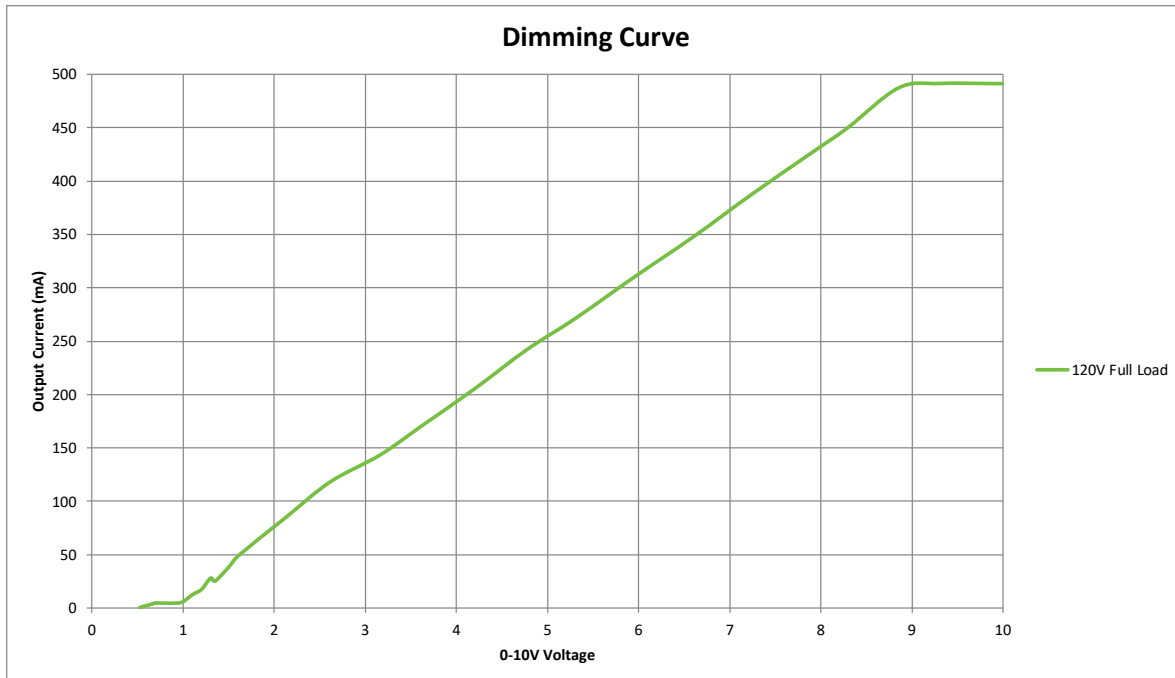

PHASE DIMMING (TRIAC & ELV)

There are two types of phase dimmers - Leading Edge and Trailing Edge

Forward Phase and **TRIAC** are leading edge dimming

Reverse Phase and **ELV** (Electronic Low Voltage) are trailing edge dimming

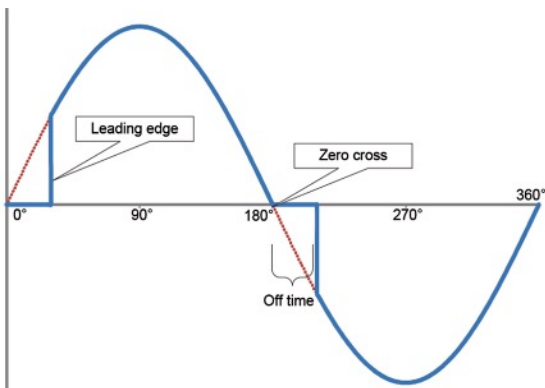

In forward phase dimming, After current crosses zero, the TRIAC component in the circuit turns off until voltage is high enough to turn it back on. This type of dimming produces an inrush current so the installer will need to calculate how many dimmers can be installed on the same circuit. This type of dimmer has a very high install base, it's very inexpensive, and easy to install with one wire.

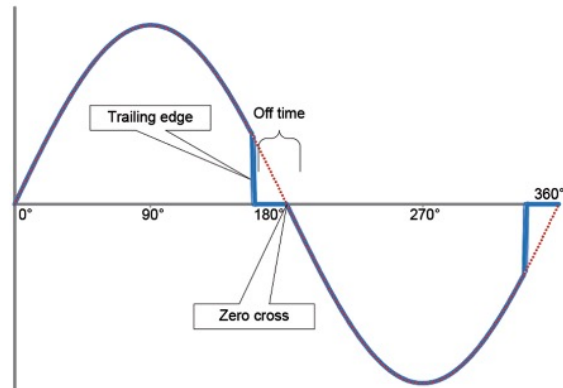

Reverse phase dimming often uses an electronic low voltage (ELV) dimmer to sense when the waveform is approaching zero then triggers the off time. It's a very stable dimming type with low inrush current and compliments LED loads very well. This type of dimmer requires a neutral wire in the junction box.

LEADING EDGE DIMMING

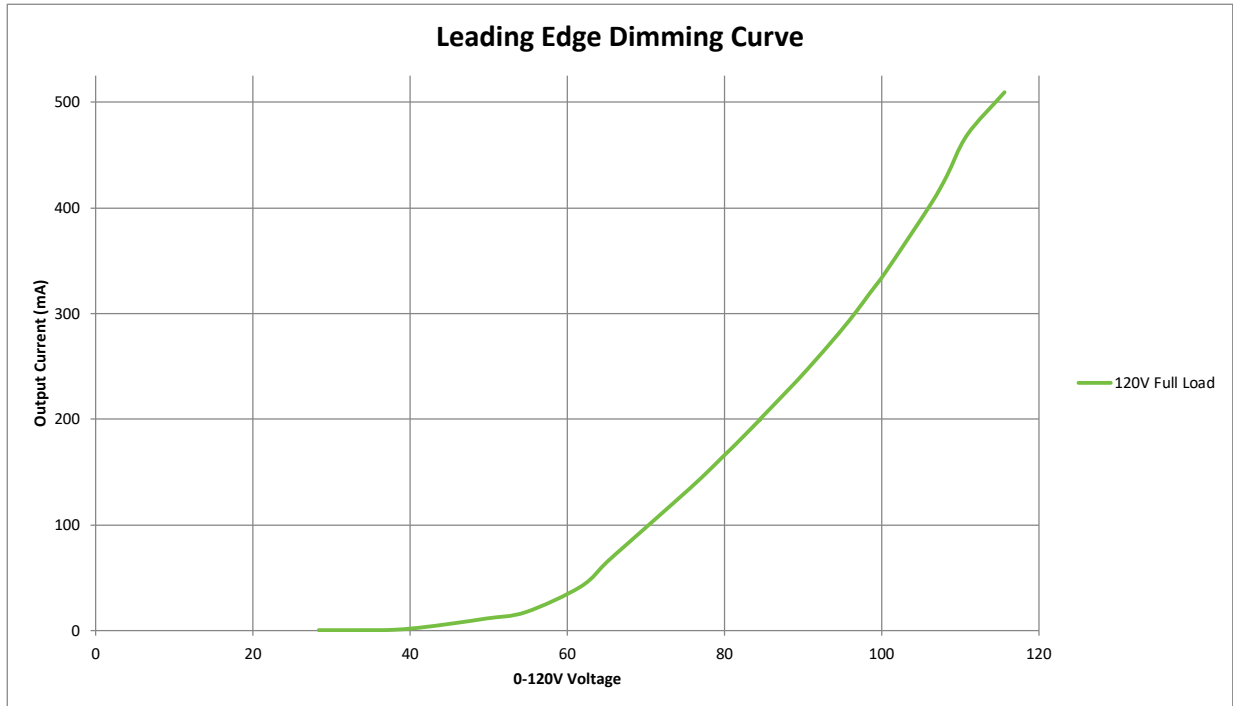

TRAILING EDGE DIMMING



COMPATIBILITY

The following dimmers have been tested to confirm compatibility:

Make	Model	Make	Model
LUTRON	Diva DVSTV Series (0-10V)	Lutron	SELV-300P (TE)
???	KD 11A010V (0-10V)		
Leviton	6613-PL (LE)		
Lutron	DV-600P-WH	Lutron	MFR2-600M-H
Lutron	N600-WH	Lutron	SLV-600P-AL
Lutron	AY-600P-AL	Lutron	DVCL-153PR-WH
Lutron	S-603P-G	Lutron	AYCL-153P-WH
Lutron	DVCL-153P-WH (DUP)	Qplus	BAK-004AG
Leviton	6672-1LW	Leviton	Sureslide 6631
Leviton	TSM10-LAW	Leviton	VP106-1LE
Leviton	IPI06	Cooper	DAL06P-C5
GE	18025	GE	18020
GE	10464	Eaton	9573
Legrand	H703PTuW	Legrand	ADTP703Tu

LIFETIME

[Lifetime Curve – life vs tc]

PERFORMANCE PLOT

