



FOUNDATION SERIES LED DRIVERS

15W PROGRAMMABLE CONSTANT CURRENT LED DRIVERS — RECTANGULAR CASE STYLE

FEATURES

- Programmable Class 2 Output
- High Power Density
- Excellent Thermal Management
- Tri-Dim Capability (1% for Triac, ELV and 0-10V)
- Dim-to-off Capability
- Universal Input Range 120V-277V
- Dry & Damp Location Rated
- Bottom Feed Option (FTY SKU)



PROGRAMMING

- Foundation Series LED drivers are software programmable using the Foundation Programming Portal. The portal can be accessed through the Google Chrome browser on Windows-Based PCs, Macs or Android devices. The Foundation USB Connector is required and the LED driver does not need to be powered on during programming.
- The Foundation Programming Portal is a secure, cloud-based application that is designed for high-volume manufacturing environments. The Portal allows users to easily set LED Driver parameters like output current, dimming curves and dim-to-off functionality. Programming profiles can be generated and stored within the Portal for easy future access and reference. Additionally, a record of all programming sessions are kept within the system and track model number, date of programming, programmed parameters and serial number.
- The Foundation USB Connector Provides a physical interface between the Foundation Series LED Driver and the programming device and is required for programming. The Foundation USB Connector can be plugged directly into a USB-A port or can utilize a USB-A adapter to connect to USB-C enabled devices.



Foundation
USB Connector

APPROVALS / CERTIFICATIONS



Patents Pending

ELECTRICAL CHARACTERISTICS

Max. Power	Programmable Current Range	Output Voltage (VDC)	Input Voltage	Dimming Type	Part Number
15W	150-350mA	20-42	120-277 VAC	Tri-Dim (TRIAC, ELV, 0-10V)	FTX15-0350T-42-UNV
		FTY15-0350T-42-UNV			
	200-500mA	15-30			FTX15-0500T-30-UNV
		FTY15-0500T-30-UNV			

INPUT SPECIFICATIONS

	FTX/FTY15-0350T-42-UNV	FTX/FTY15-0500T-30-UNV
Input Voltage	90-305 VAC (120/277 VAC Nominal)	90-305 VAC (120/277 VAC Nominal)
Input Frequency	47-63Hz (50/60 Nominal)	47-63Hz (50/60 Nominal)
Input Current (120/277)	0.14/0.06 A	0.14/0.06 A
Power Factor (120/277)	0.99/0.90	0.99/0.90
THD (120/277)	7/11%	4/11%
Efficiency (120/277)	83/83%	83/83%

Input Characteristics: Nominal Input Voltage, Max Load, No Dimmer

OUTPUT SPECIFICATIONS

	FTX/FTY15-0350T-42-UNV	FTX/FTY15-0500T-42-UNV	Notes
Output Current Programmable Range	150-350mA	200-500mA	
Output Voltage Range	20-42VDC	15-30VDC	
Output Current Load Regulation	5%		Nominal Input Voltage, full programmed current range
Output Current Line Regulation	5%		Max load voltage, full programmed current range
Output Current Overshoot	10%		<500ms
Start-Up Time	<500ms	<500ms	120VAC, full load
Stand-By Power (120/277)	0.35/1.48W	0.64/1.31W	Conforms to NEMA SSL7A & DLC Standby Power Requirements

PROTECTIONS

Output Overcurrent Protection: Hiccup Mode with Auto Recovery. When the load current exceeds the programmed current by 15%, the output will go into hiccup mode (pulsing between full output and less than full output) and will auto-recover when the fault is removed.

Output Short Circuit Protection: Hiccup Mode with Auto Recovery. When the output leads are shorted, the output will go into hiccup mode (pulsing between full output and less than full output) and will auto-recover when the fault is removed.

Over Temperature Protection: Fold Back with Auto Recover. When the internal temperature sensor senses the LED driver above the rated T_c by 6°C , the output current will fold back below the programmed current output and will recover when the temperature stabilizes to the normal value.

ENVIRONMENTAL SPECIFICATIONS

		Min	Nom	Max	Notes
Max Case Temp				85°C	At Tc Location
Storage Temp		-40°C		85°C	
Humidity				95%	Non-condensing
Acoustic Noise	Class A		<24dB		Measured 1m Distance
MTBF (Hrs)				350,000	At Max Load and Tc <70°C

SIZING INFORMATION - in [mm]

FTX - Side Lead Models

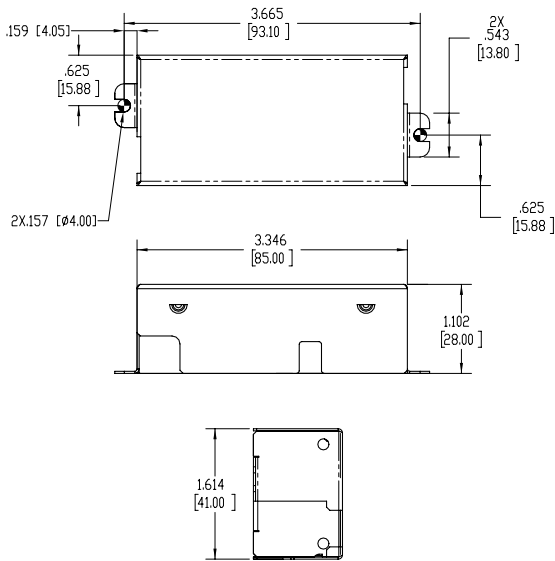

FTY - Bottom Feed Models

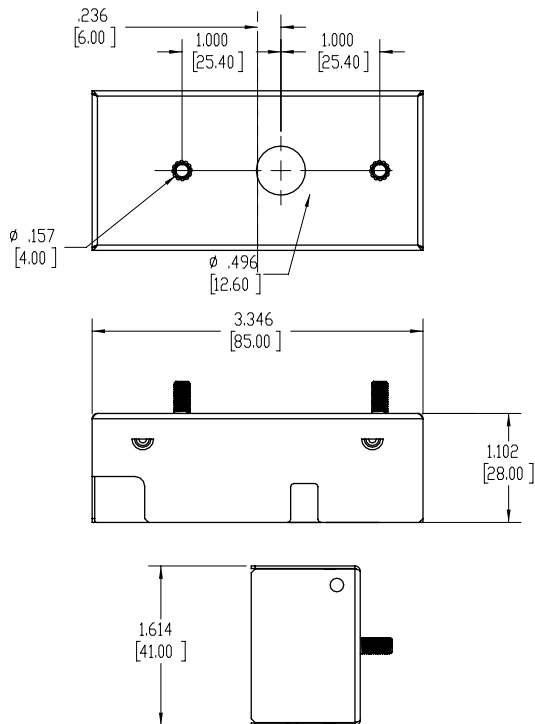

SAFETY, EMC COMPLIANCE

UL, cUL	UL8750, Listed Class P
FCC 47CFR Part 15	ANSI C63.4:2009 Class B (Consumer Limits) @120VAC, Class A (Commercial) @277
Declare	RoHS compliant, approved component
NEMA SSL7A, DLC	Complies with startup requirements
Surge Protection	2.5kV/1.2kA

WIRING INFORMATION

Input	AWM 1430 6" Black (L); 6" White (N); 18AWG
Output	AWM 1569 6" Red (+); 6" Blue (-); 18AWG
Dimming	AWM 1430 6" Purple (+); 6" Pink (-); 24AWG

*Bottom feed hole and stud mounting is off center on purpose

PACKAGING INFORMATION

Package Weight	6.2oz
Quantity	50pcs/carton

PART NUMBER DECODING

FTX15 - 0350T-42-UNV

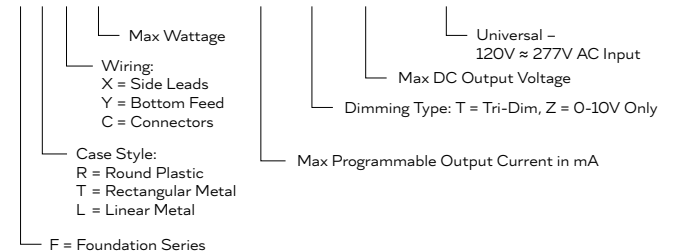

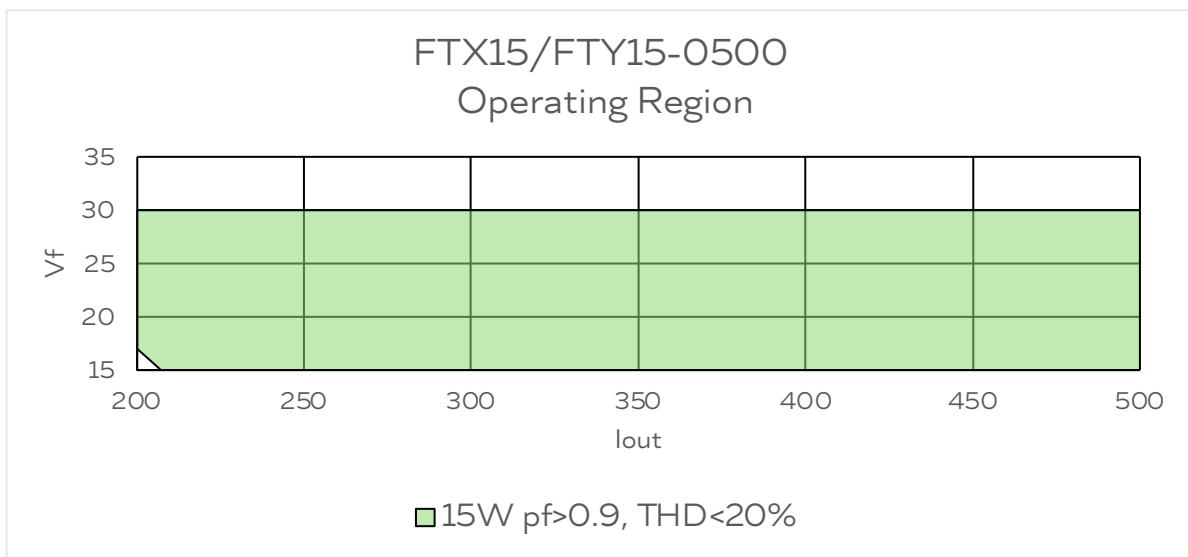
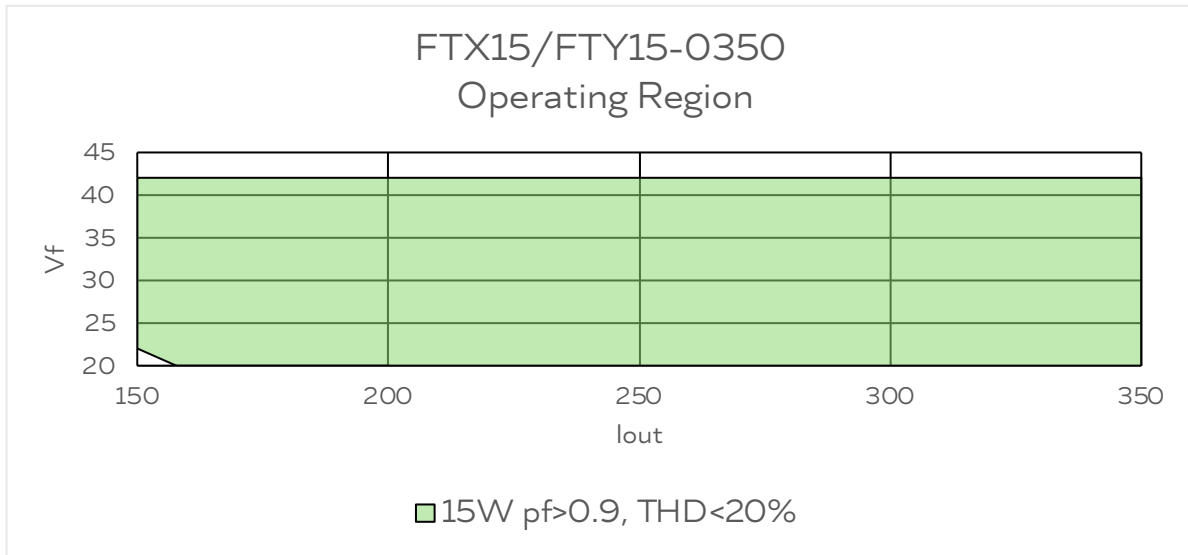

STATEMENTS AND NOTATIONS

Each unit ships programmed to the maximum output current. To program the output to a different current, please refer to the Programming section of this specification.

As a general design guideline, the nominal Vf of the LED load should be >3V below the Vf max rating of the driver to provide room for cold start LED voltage drift.

LIFETIME

Lifetime vs Tc (Case Temperature) is a calculation to guide designers to understand how long the LED driver will provide power conforming to its specifications if run continuously for 24hrs a day, 365 days a year compared to the measured Tc point in the application. This calculation is based on the lifetime of the shortest life electrolytic capacitor operating under the worst case electrical configuration and takes into account the various temperature and electrical characteristics that affect the capacitor's lifetime.

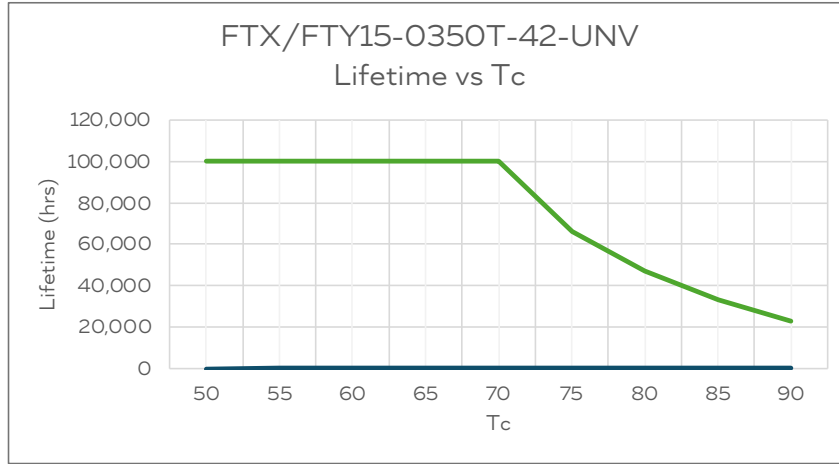

PERFORMANCE PLOT

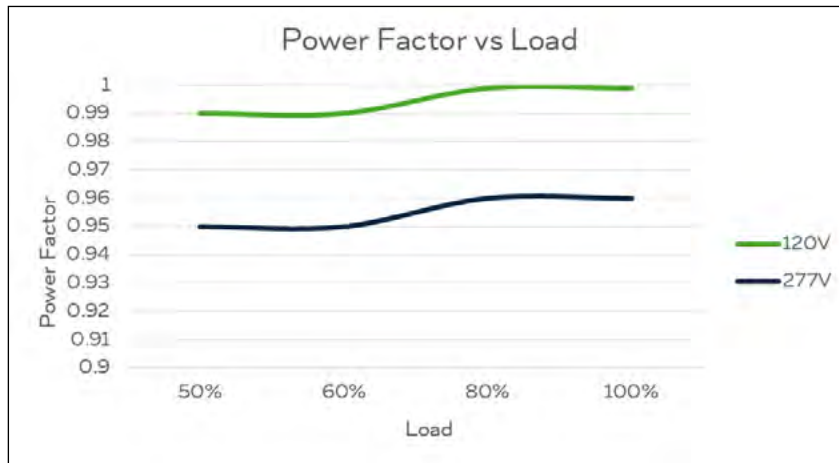
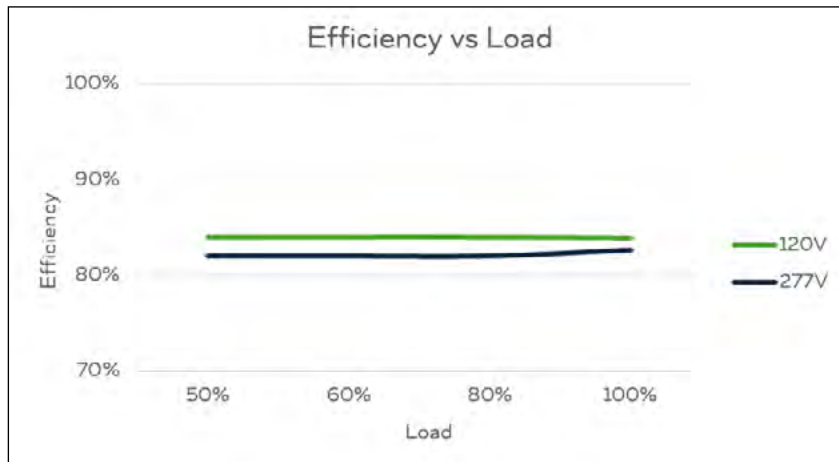

DIMMING CHARACTERISTICS - 0-10V

Hatch Foundation series source current for the 0-10V dimming connections and therefore, use 0-10V dimmers that sink current. The dimming is related to the programmed output current.

The dim voltage maximum and minimum levels can be set withing the Portal to match with a preferred dimming control system. The driver is shipped by default with the upper voltage set to 10V and the lower voltage set to 1V. During programming, the upper voltage can be set to a value between 7V and 10V in 0.1V increments which corresponds to the voltage where the output will change from full output to dimming output. The lower voltage can be set from 0.5V to 1.2V in 0.1V increments which corresponds to when the light output will achieve the minimum dimming setting.

The driver ships with minimum dimming set at 1% and can be programmed to 5% and 10%, linear or logarithmic. Dim-to-Off capability can also be programmed which allows the user to select the dim-to-off voltage setting for powering the driver on and off. The driver ships with 0-10V settings that conform to ANSI C137.1 Lighting Systems - 0-10V Dimming Interface for LED Drivers, Fluorescent Ballasts, and Controls.

Hatch conducts dimmer compatibility testing with an extensive list of 0-10V dimmers. 0-10V dimmers operate very similarly, therefore, a 0-10V dimmer compatibility list is not provided in this specification.

	Min	Typical	Max	Notations
Default Profile (V)	1		9	
Dim Range (%)	1%		100%	Default min dim 1%. Can be set via programming (1%, 5%, 10%)
Upper Voltage (V)	8	10	10	Programmable; Upper voltage to achieve full light output
Lower Voltage (V)	0.75	1	1.5	Programmable; Lower Voltage to achieve min. light output or dim-to-off voltage
Current Supplied (mA)	0.23	0.25	0.27	Source current from driver to 0-10V control
Dim-to-Off Voltages	0.7		0.8	Programmable; Turn-on and Turn-off voltages can be set individually

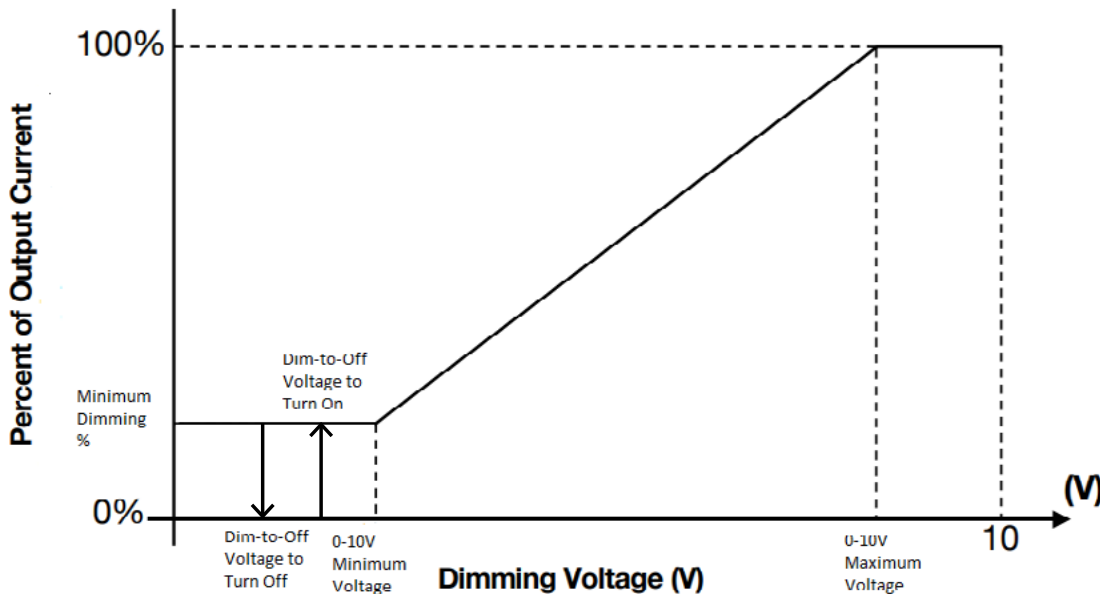

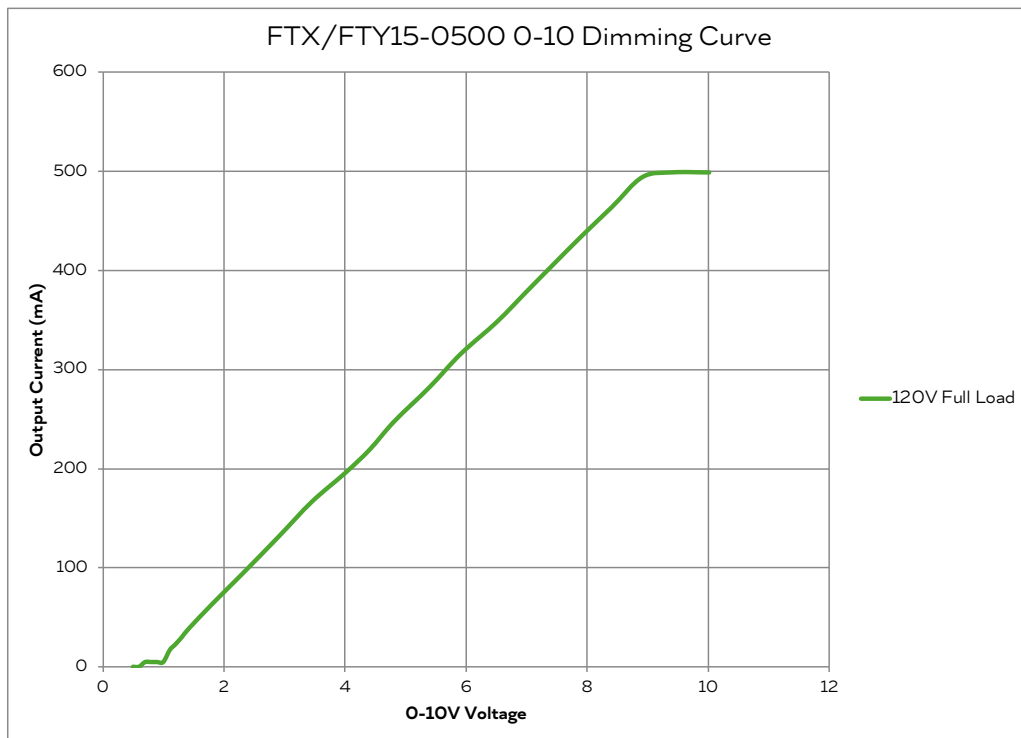
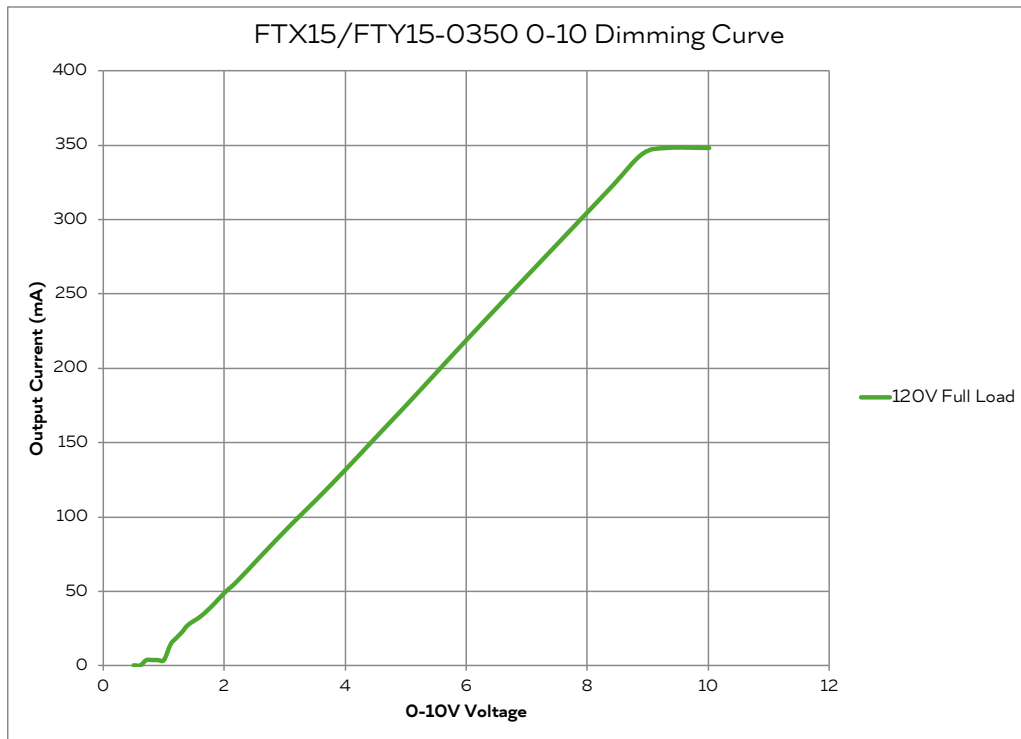

There are two types of phase dimmers - Leading Edge and Trailing Edge

Forward Phase and **TRIAC** are leading edge dimming

Reverse Phase and **ELV** (Electronic Low Voltage) are trailing edge dimming

For more detailed information on Phase Dimming, please refer to our [Technical Guide For Phase Dimming](#)

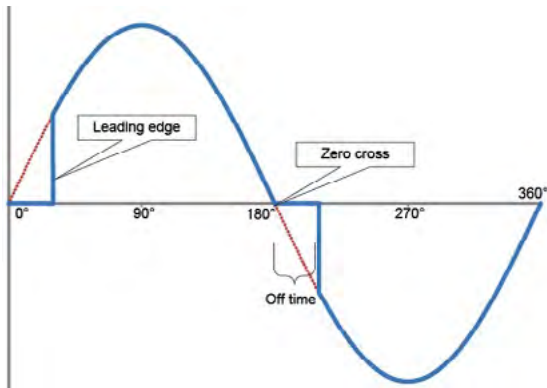

In forward phase dimming, after current crosses zero, the **TRIAC** component in the circuit turns off until voltage is high enough to turn it back on. This type of dimming produces an inrush current so the lighting fixture installer will need to calculate how many dimmers can be installed on the same circuit. This type of dimmer has a very high installed base in the United States, is very inexpensive and is easy to install with one wire.

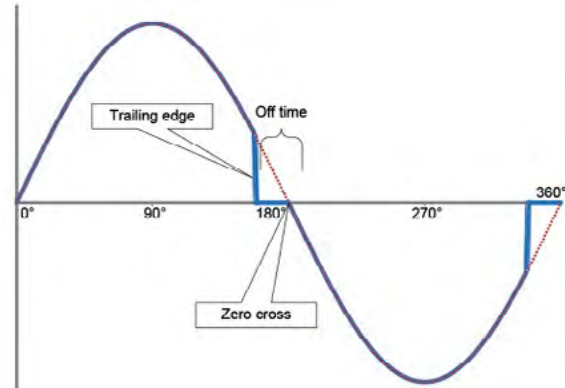

Reverse phase dimming often uses an electronic low voltage (ELV) dimmer to sense when the waveform is approaching zero then triggers the off time. It is a very stable dimming type with low inrush current and compliments LED loads very well. This type of dimmer requires a neutral wire in the junction box.

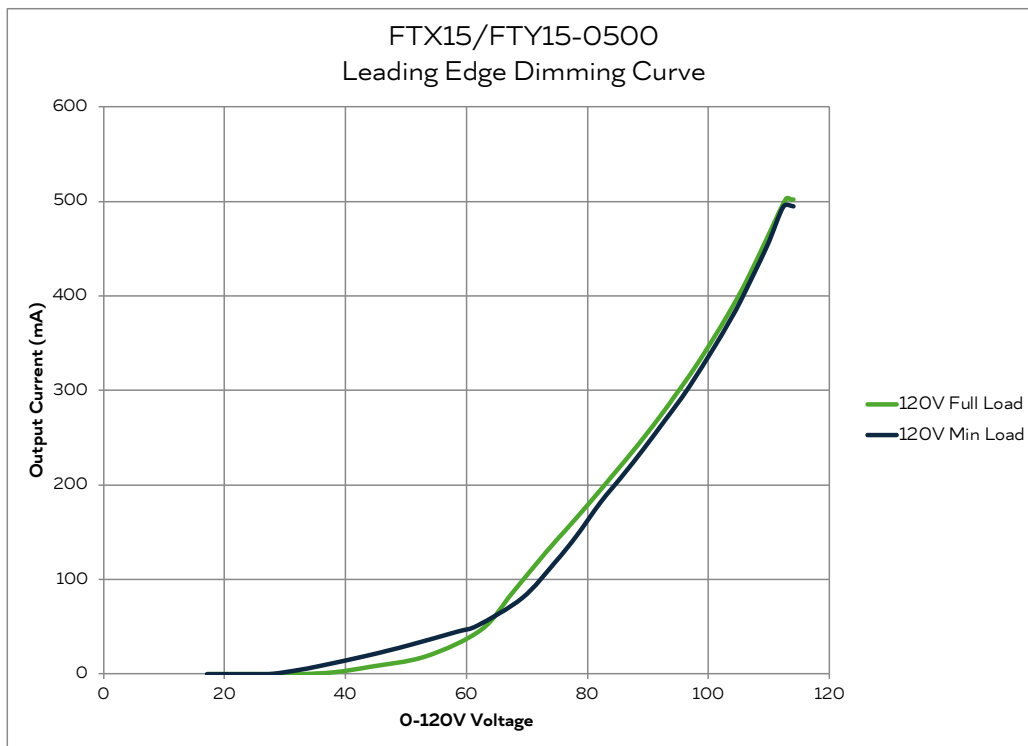
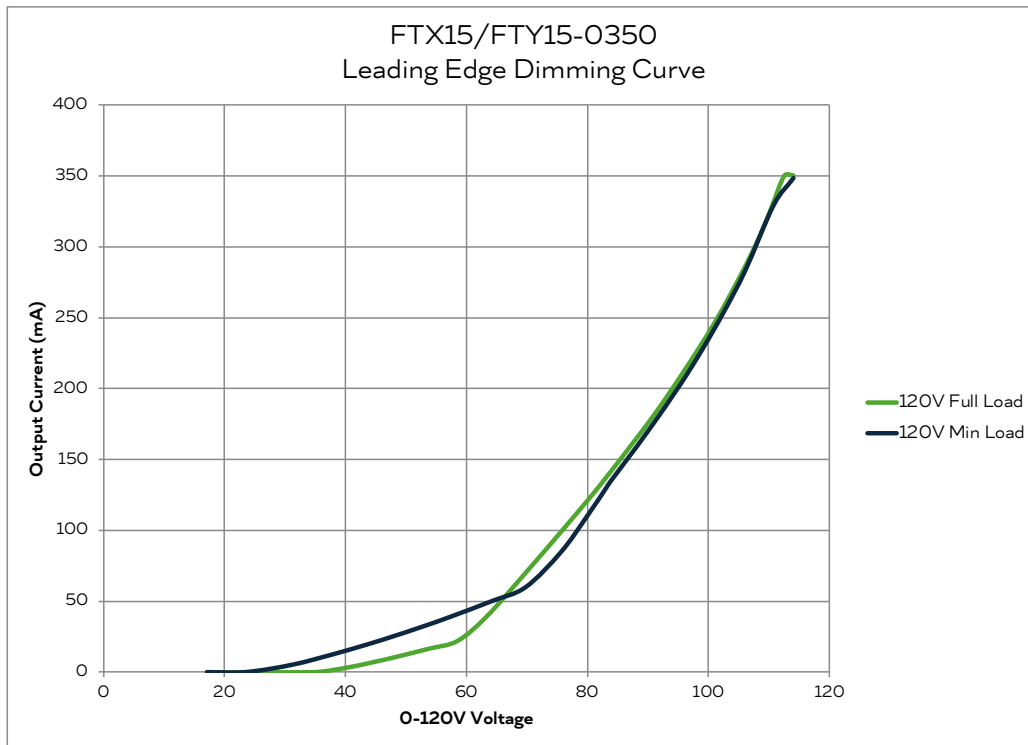

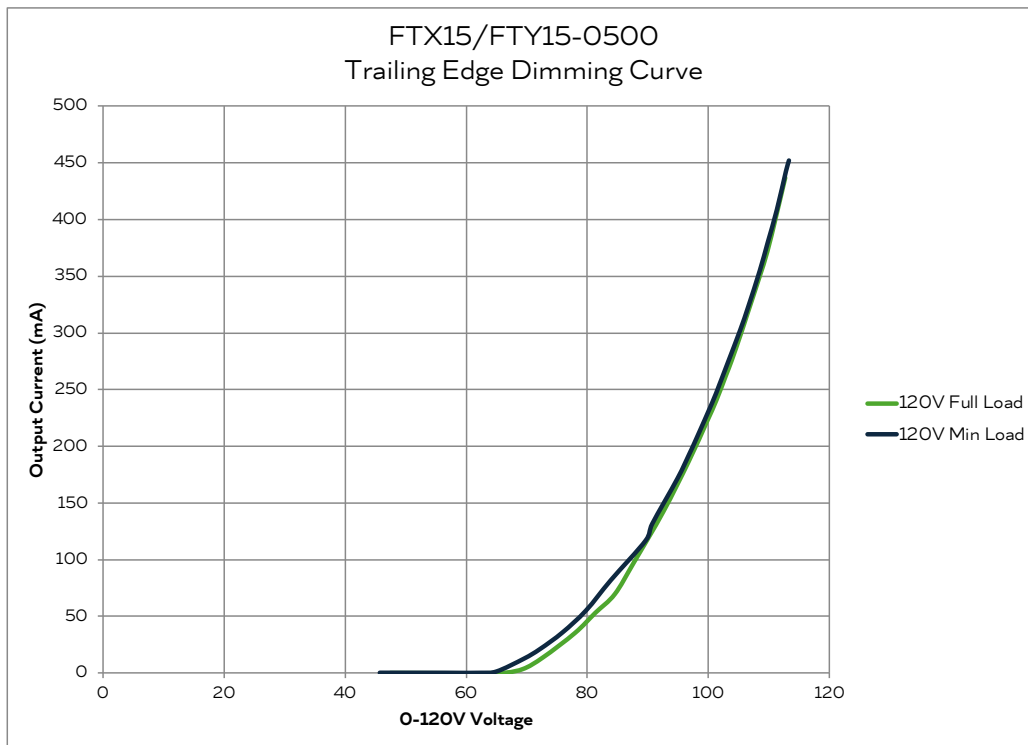
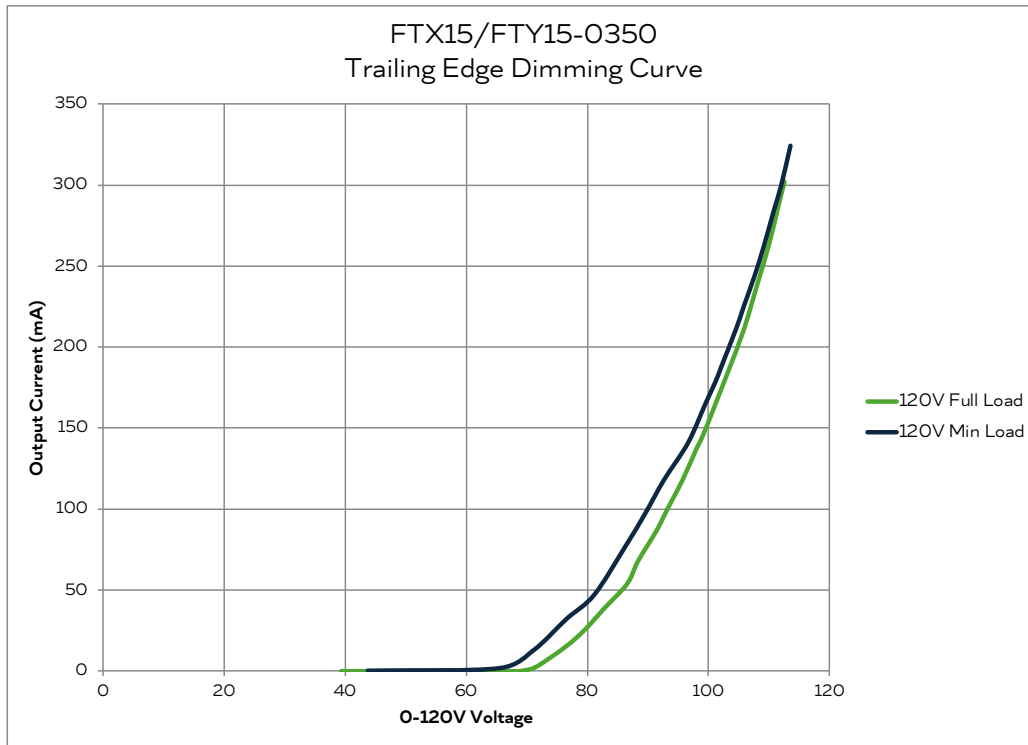

COMPATIBILITY

The following phase dimmers have been tested to confirm compatibility:

Make	Model	Type
Lutron	SELV-300P	ELV
Lutron	DVELV-300P	ELV
Lutron	MAELV-600M	ELV
Lutron	MFR2-6ELV	ELV
Lutron	DVCL-153P	LED
Lutron	AYCL-153P	LED
Lutron	MACL-153M	LED
Lutron	CTCL-153P	LED
Lutron	STCL-153M	LED
Lutron	TGCL-153P	LED
Lutron	LECL-153P	LED
Lutron	CTCL-150	LED
Lutron	LECL-150	LED
Lutron	PD-6WCL	LED
Lutron	DVRF-6L	LED
Lutron	MA-PRO	LED
Leviton	6672	LED
Leviton	6674	LED
LeGrand	ADTP703Tu	LED

NOTE: Most phase dimmers have trim settings. These trim settings allow for adjustment of the dimmer to achieve acceptable performance for an installation.

Hatch conducts extensive dimmer compatibility testing using a wide variety of popular dimmers and LED loads. Every LED lighting system is different and dimming performance is affected by the LED driver, LED load, system wiring, dimmer model, and dimmer setting. Hatch recommends customers test with system components to verify acceptable dimming performance.

Due to multiple variables affecting phase dimming in LED lighting systems, Hatch recommends a maximum of 8 drivers per dimmer circuit.

PROGRAMMING

Foundation Series LED drivers are software programmable using the Foundation Programming Portal. The portal can be accessed through the Google Chrome browser on Windows-Based PCs, Macs or Android devices. The Foundation USB Connector is required and the LED driver does not need to be powered on during programming.

A complete guide for utilizing the Portal can be found at this link: [Foundation Programming Portal User Guide](#)

Foundation Programming Portal

The Foundation Programming Portal is a secure, cloud-based application that is designed for high-volume manufacturing environments. The Portal allows users to easily set LED Driver parameters like output current, dimming curves and dim-to-off functionality. Programming profiles can be generated and stored within the Portal for easy future access and reference. Additionally, a record of all programming sessions are kept within the system and track model number, date of programming, programmed parameters and serial number.

The Foundation Portal can be accessed via this link: foundation.hatchlighting.com

When you first access the portal, you will be required to request access from Hatch. This is a one-time process which allows Hatch to increase the security of the application and ensure that only real, active customers are utilizing the system. You will see a "Request Access" button at the top right of the page. Please click this link and fill out the requested information at the linked page.

Foundation USB Connector

The Foundation USB Connector provides a physical interface between the Foundation Series LED Driver and the programming device and is required for programming. The Foundation USB Connector can be plugged directly into a USB-A port or can utilize a USB-C adapter to connect to USB-C enabled devices. Each new Foundation Series order will come with a Foundation USB Connector provided free-of-charge. Additional units can be purchased through Hatch.

PROGRAMMING

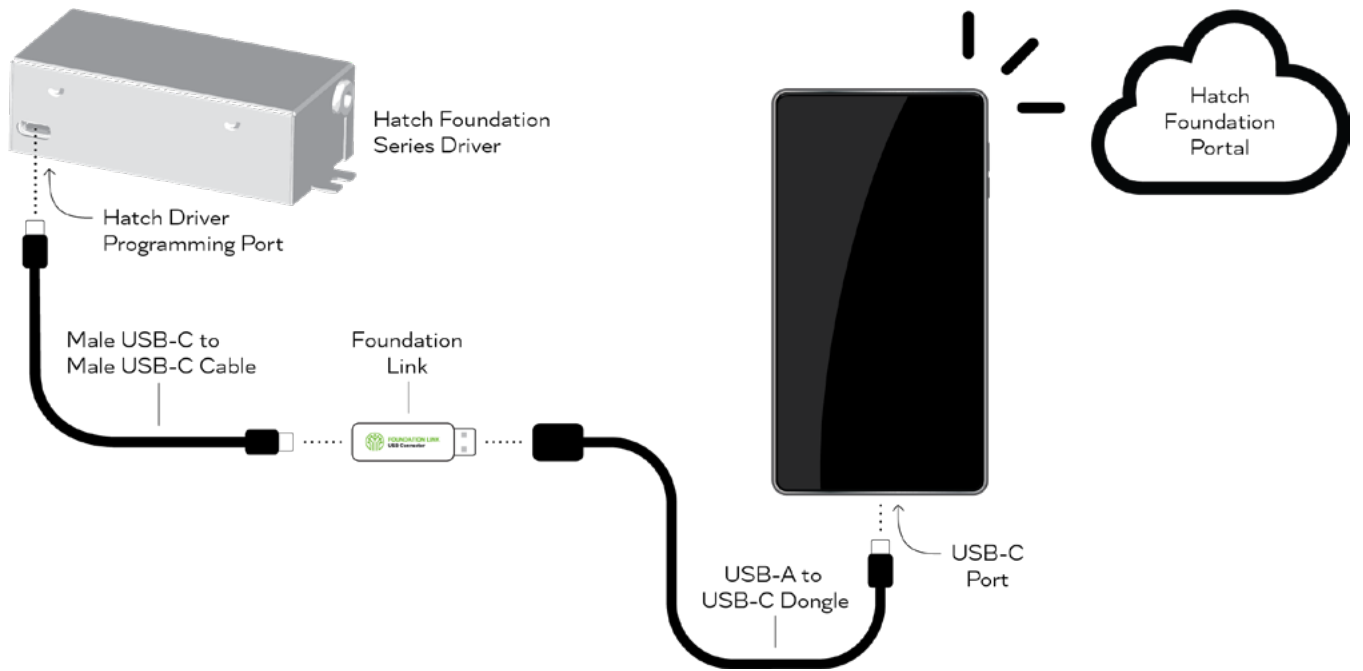
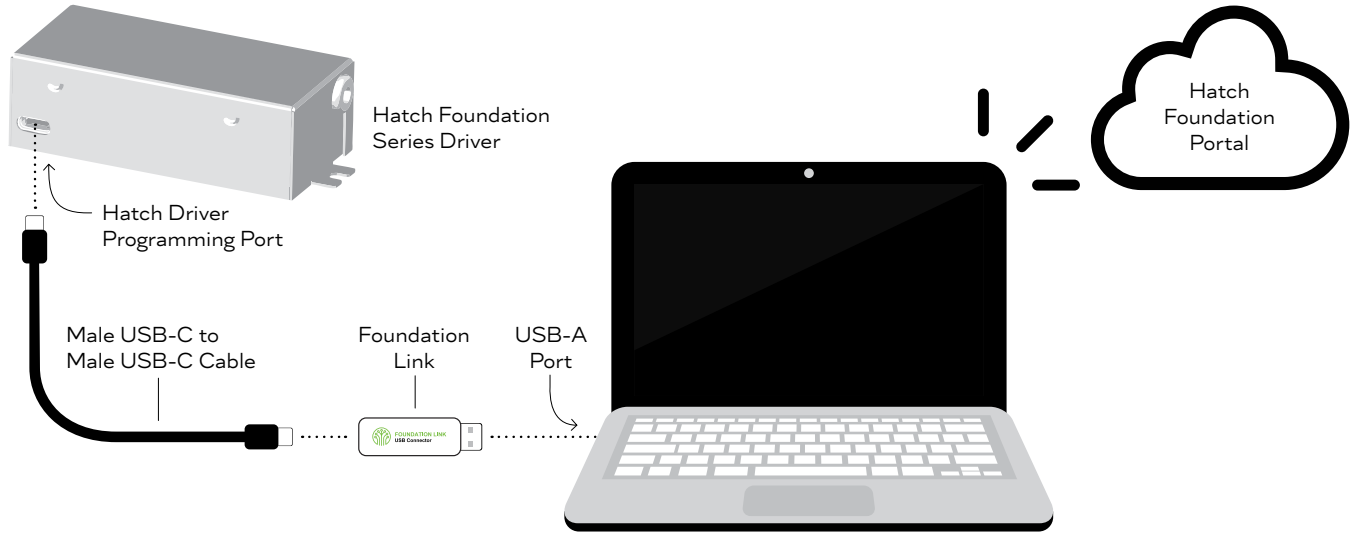

PRODUCT LABELS



FOUNDATION SERIES

FTX15-0350T-42-UNV
15W Programmable Constant Current LED Driver

↑ PROG

RED: +LED
BLUE: -LED

PURPLE: +DIM
PINK: -DIM

INPUT

120-277VAC
0.15/0.06A

50/60Hz

BLACK: L
WHITE: N

Patents Pending



www.HatchLighting.com

OUTPUT

150 - 350mA
20 - 42V DC

Class 2

TRIAC, ELV, 0-10V Dimming
CAN ICES-005 (B) NMB-005 (B)



7 97281 74003 8







FOUNDATION SERIES

FTX15-0500T-30-UNV
15W Programmable Constant Current LED Driver

↑ PROG

RED: +LED
BLUE: -LED

PURPLE: +DIM
PINK: -DIM

INPUT

120-277VAC
0.15/0.06A

50/60Hz

BLACK: L
WHITE: N

Patents Pending



www.HatchLighting.com

OUTPUT

200 - 500mA
15 - 30V DC

Class 2

TRIAC, ELV, 0-10V Dimming
CAN ICES-005 (B) NMB-005 (B)



7 97281 74004 5







FOUNDATION SERIES

FTY15-0350T-42-UNV
15W Programmable Constant Current LED Driver

INPUT

120-277VAC
0.15/0.06A

50/60Hz

OUTPUT

20-42V DC
150-350mA

Class 2

BLACK: L
WHITE: N

RED: +LED
BLUE: -LED

PURPLE: +DIM
PINK: -DIM

Patents Pending



www.HatchLighting.com

TRIAC, ELV, Class 2 0-10V Dimming
Tc Max 85° C • Damp Location
CAN ICES-005 (B) NMB-005 (B)



7 97281 74005 2





↓ PROG



FOUNDATION SERIES

FTY15-0500T-30-UNV
15W Programmable Constant Current LED Driver

INPUT

120-277VAC
0.15/0.06A

50/60Hz

OUTPUT

15-30V DC
200-500mA

Class 2

BLACK: L
WHITE: N

RED: +LED
BLUE: -LED

PURPLE: +DIM
PINK: -DIM

Patents Pending



www.HatchLighting.com

TRIAC, ELV, Class 2 0-10V Dimming
Tc Max 85° C • Damp Location
CAN ICES-005 (B) NMB-005 (B)



7 97281 74006 9





↓ PROG